

MICRO LAB • ADAPTERS

QM-100 ADAPTER, 75° ANGLE

Inner joints of the same size at both ends.

Joint Size	Code
14/20	-10
19/22	-11

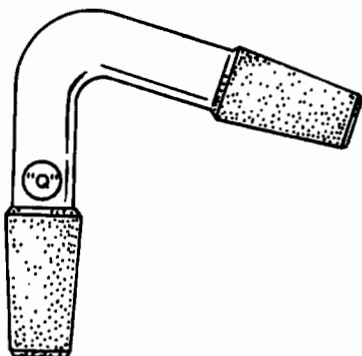

QM-140 ADAPTER, BUSHING

Reducing adapters with an inner joint on the outside and an outer joint on the inside.

Inner (Outside)	Outer (Inside)	Code
14/20	10/18	-10
14/20	10/30	-11
19/22	14/20	-12

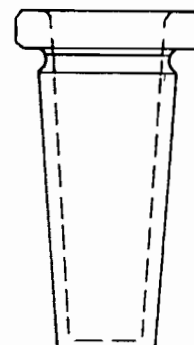

QM-110 ADAPTER, 105° ANGLE

Outer joint at one end with inner joint of the same size at the other end.

Joint Size	Code
14/20	-10
19/22	-11

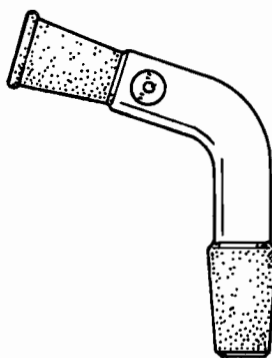

QM-150 ADAPTER, STRAIGHT

An outer joint at the top with inner joint of the same size at the bottom.

Joint Size	Code
14/20	-10
19/22	-11



QM-120 ADAPTER, DELIVERY TUBE

Outer joint with tube on a 105° angle and cut to drip tip.

Joint Size	Code
14/20	-10
19/22	-11

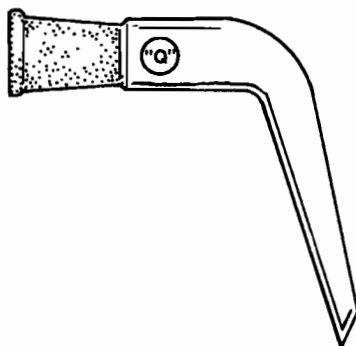

QM-160 ADAPTER, STRAIGHT

A socket joint at the top with a ball joint of the same size at the bottom.

Joint Size	Code
18/9	-10

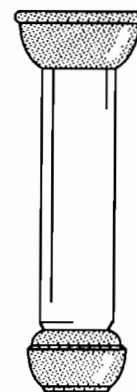

QM-130 ADAPTER, DELIVERY TUBE

Inner joint with a 6" side arm on a 75° angle.

Joint Size	Code
14/20	-10
19/22	-11

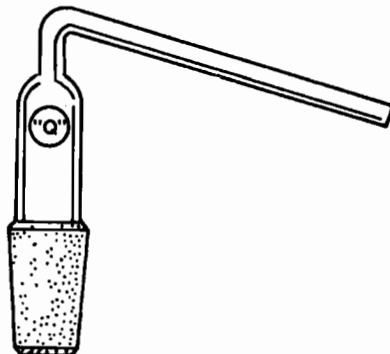

QM-170 ADAPTER, OFFSET

An outer joint at top with an inner joint of the same size at the bottom.

Joint Size	Code
14/20	-10
19/22	-11

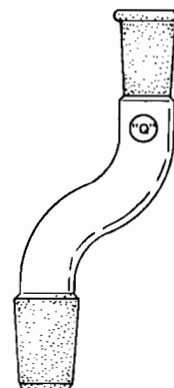

MICRO LAB • ADAPTERS

QM-180 ADAPTER REDUCING & ENLARGING

For connecting apparatus with different size joints.

Top Outer	Bottom Inner	Code
10/30	14/20	-10
10/30	19/22	-11
14/20	10/30	-12
14/20	19/22	-13
14/20	24/40	-14
19/22	10/30	-15
19/22	14/20	-16
19/22	24/40	-17
24/40	14/20	-18
24/40	19/22	-19
29/42	14/20	-20
29/42	19/22	-21

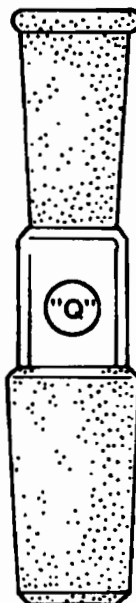

QM-210 ADAPTER INLET, OUTLET

Inner joint with a 90° angle hose connection.

Joint Size	Code
14/20	-10
19/22	-11

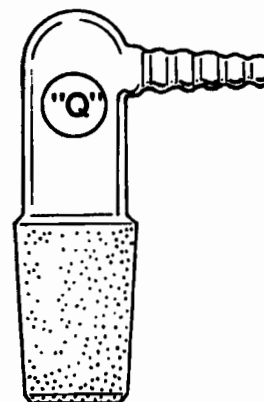

QM-220 ADAPTER INLET, OUTLET

Outer joint with a 90° angle hose connection.

Joint Size	Code
14/20	-10
19/22	-11

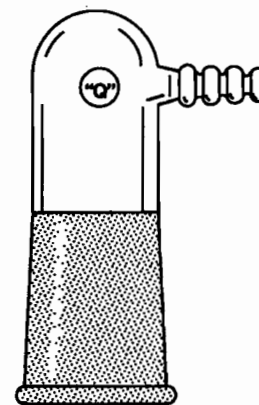

QM-190 ADAPTER INLET, OUTLET

Vertical hose connection above an inner joint.

Joint Size	Code
14/20	-10
19/22	-11



QM-230 ADAPTER RIGHT ANGLE

Inner joint with a 2mm stopcock and a right angle hose connection. Available with a glass or teflon stopcock.

Joint Size	Stopcock	
	Glass Code	Teflon Code
14/20	-10	-22
19/22	-11	-23

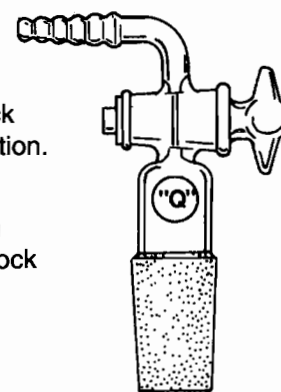

QM-200 ADAPTER INLET, OUTLET

Hose connection above an outer joint.

Joint Size	Code
14/20	-10
19/22	-11

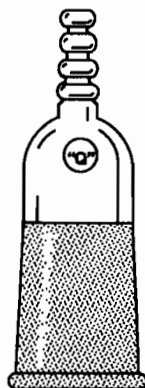

QM-240 ADAPTER 3 WAY, 75°

Outer joint with inner joints of the same size on the bottom and side.

Joint Size	Code
14/20	-10
19/22	-11

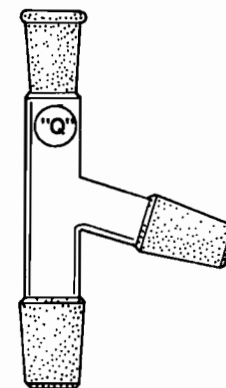

MICRO LAB • ADAPTERS

QM-250 ADAPTER 3 WAY, 75°

Top 10/18 outer joint for thermometer, with inner joints of the same size on the bottom and side.

Joint Size	Code
14/20	-10
19/22	-11

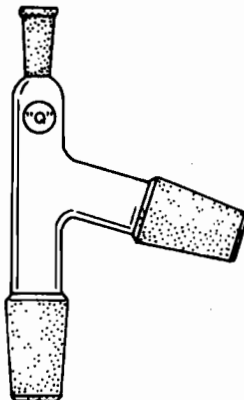

QM-290 ADAPTER 3 WAY, CLAISEN

Similar to QM-280, but with an internal threaded joint with bushing and O ring at top to hold thermometers or bleed tubes.

Joint Size	Code
14/20	-10
19/22	-11

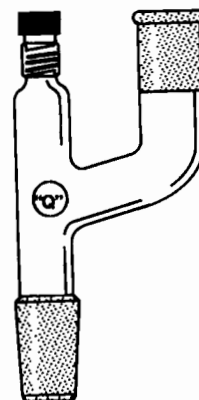

QM-260 ADAPTER 3 WAY, 75°

Top rubber connector holds a thermometer or bleed tube, with inner joints of the same size on the bottom and side.

Joint Size	Code
14/20	-10
19/22	-11

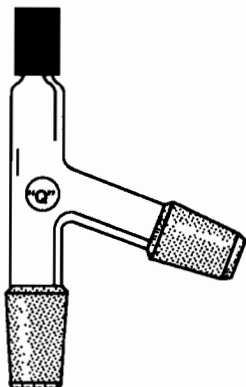

QM-300 ADAPTER 3 WAY, CLAISEN

Outer joints at top with inner joint at bottom. All joints are the same size.

Joint Size	Code
14/20	-10
19/22	-11

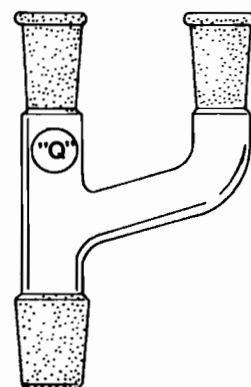

QM-270 ADAPTER 3 WAY, 75°

Top internal threaded joint with bushing and O ring holds a thermometer or bleed tube, with inner joints of the same size on the bottom and side.

Joint Size	Code
14/20	-10
19/22	-11

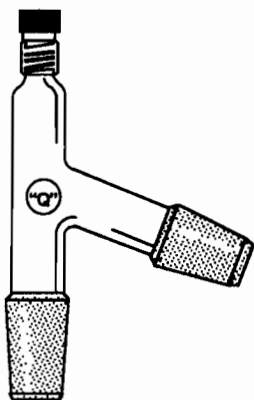

QM-310 ADAPTER, 4 WAY

Outer joints at top with an inner joint at the bottom. All joints are the same size.

Joint Size	Code
14/20	-10
19/22	-11

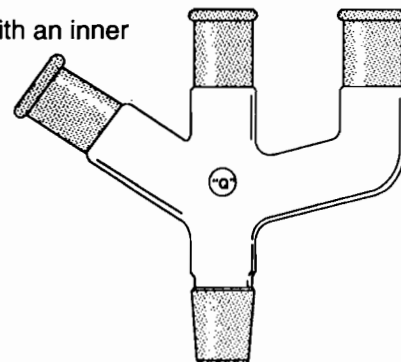

QM-280 ADAPTER 3 WAY, CLAISEN

The side arm outer joint and the bottom inner are the same size. The 10/18 outer joint at top is for thermometers.

Joint Size	Code
14/20	-10
19/22	-11

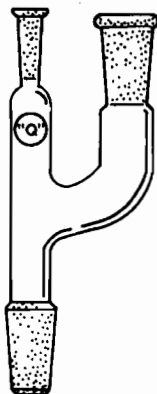

QM-320 ADAPTER, 4 WAY

The outer joint on the arm is a 10/18 for a thermometer. The outer joint on the main tube and the lower inner joints are the same size.

Joint Size	Code
14/20	-10
19/22	-11

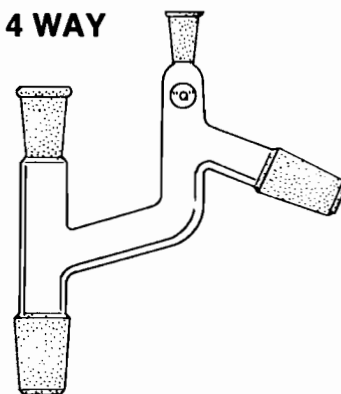

MICRO LAB • ADAPTERS

QM-330 ADAPTER, 4 WAY

Similar to QM-320, but the side arm has an internal threaded joint with bushing and O ring to hold thermometers or bleed tubes.

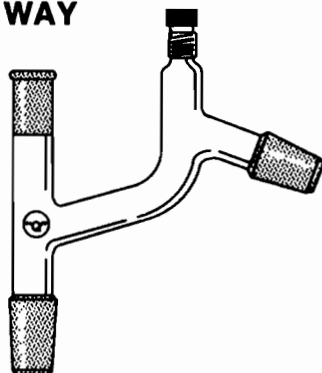

Joint Size	Code
14/20	-10
19/22	-11

QM-360 ADAPTER, GAS INLET

Plain tube with a tapered delivery end which has a capillary opening. 7mm OD x 280mm long.

Code
-10



QM-340 ADAPTER, TAKE OFF

The joint on the main tube is a 10/18 for thermometers. Take off arm is at a 75° angle to the main tube with a 1mm stopcock and drip joint. All joints are the same size. Available with a glass or teflon stopcock.

Joint Size	Stopcock	
	Glass Code	Teflon Code
14/20	-10	-22
19/22	-11	-23

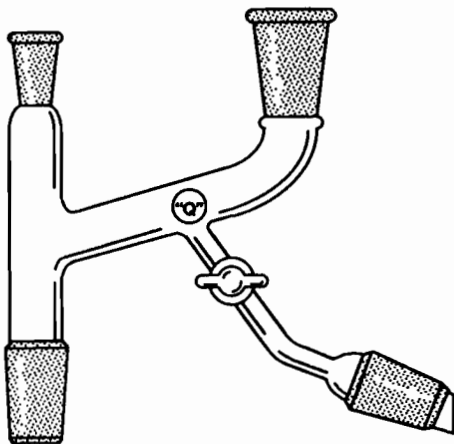

QM-370 ADAPTER, GAS INLET

A straight delivery tube under an inner joint with hose connection.

Joint Size	Stem Length, MM	Code
10/18	60	-10
10/30	60	-11
14/20	75	-12
19/22	75	-13



QM-380 ADAPTER THERMOMETER

Inner joint with a rubber fitting for a thermometer or inlet tube.

Joint Size	Code
14/20	-10
19/22	-11



QM-350 ADAPTER, CONNECTING

Two inner joints of the same size spaced either 100mm or 150mm apart.

Joint Size	Apart	
	100mm Code	150mm Code
14/20	-10	-22
19/22	-11	-23

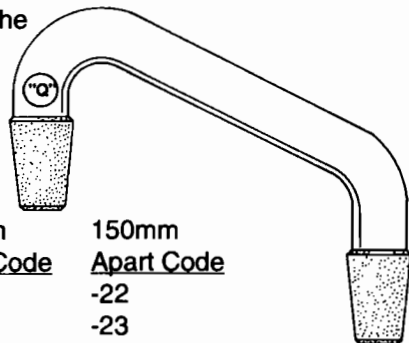

QM-390 ADAPTER THERMOMETER

Inner joint with a top rubber fitting for a thermometer or inlet tube and side hose connection.

Joint Size	Code
14/20	-10
19/22	-11

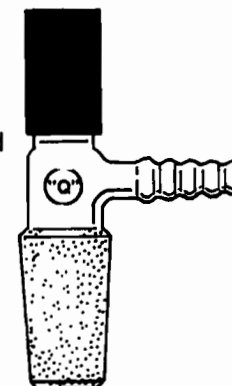

MICRO LAB • ADAPTERS

QM-400 ADAPTER THERMOMETER

Inner joint with an internal threaded joint with bushing and O ring for a thermometer or inlet tube.

Joint Size	Code
14/20	-10
19/22	-11



QM-440 ADAPTER, VACUUM

Outer joint at top with inner joint of the same size at bottom with a side hose connection.

Joint Size	Code
14/20	-10
19/22	-11

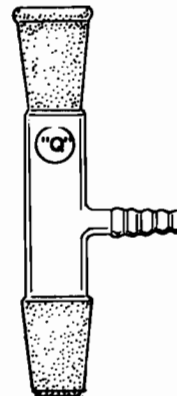

QM-410 ADAPTER, THERMOMETER TEFLON

Made entirely of teflon with locking nut and O ring to seal around thermometers or bleed tube at desired depth.

Joint Size	For Use With	
	Outer Sizes	Code
10/18	10/18, 10/30	-10
14/20	14/20, 14/35	-11
19/22	19/22, 19/38	-12

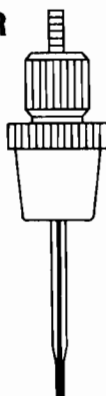

QM-450 ADAPTER, VACUUM

Outer joint at top with inner joint of the same size at bottom. Delivery tube is sealed in above a side hose connection.

Joint Size	Code
14/20	-10
19/22	-11

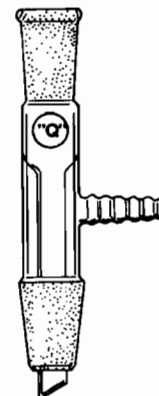

QM-420 ADAPTER THERMOMETER

Inner joint with a top internal threaded joint with bushing and O ring for thermometer or inlet tube and side hose connection.

Joint Size	Code
14/20	-10
19/22	-11



QM-460 ADAPTER VACUUM, 105°

Outer joint at top on a 105° angle with inner joint of the same size at bottom. Delivery tube is sealed in above a side hose connection.

Joint Size	Code
14/20	-10
19/22	-11

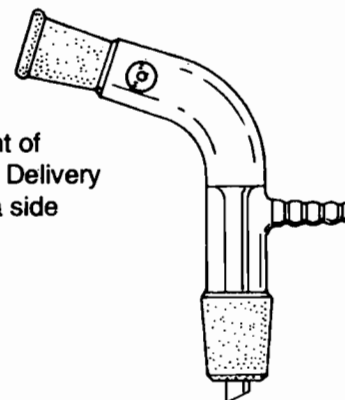

QM-430 ADAPTER THERMOMETER

Inner joint with a 10/18 outer joint at top for thermometer and side hose connection.

Joint Size	Code
14/20	-10
19/22	-11

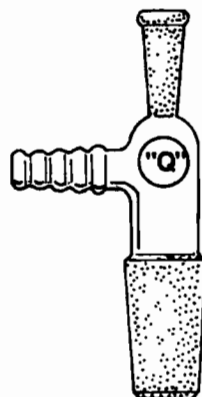

REMEMBER

"Q" Glass has been working with customers to design and build custom glass apparatus and component parts since 1946. We can do the same for you. Please write or call us with your special requirements.