

FLASKS

QF-900 DEWAR, LOW FORM HEMISPHERICAL

Low form with hemispherical borosilicate glass liner, silvered and evacuated. Mounted in an aluminum base which extends to the mouth of the flask. Low form shallow dewars permit many essential operations not practical with standard dewars. Vacuum tip-off tubulation is offset to minimize space between dewar bottoms and magnetic stirrers.

Capacity <u>ML</u>	Inside Diameter <u>MM</u>	Inside Depth <u>MM</u>	Holds Flask <u>ML</u>	<u>Code</u>
125	80	40	100	-110
275	100	55	250	-111
600	140	65	500	-112



QF-910 DEWAR, LOW FORM CYLINDRICAL

Similar to QF-900, but the glass liner is cylindrical for increased coolant capacity. Dewars have a semi flat bottom.

Capacity <u>ML</u>	Inside Diameter <u>MM</u>	Inside Depth <u>MM</u>	Holds Flask <u>Size, ML</u>	<u>Code</u>
150	80	35	100	-110
350	80	75	100	-111
850	130	75	500	-112
2500	170	135	1000	-113

QF-920 DEWAR, NARROW MOUTH SPHERICAL

Borosilicate glass, silvered and evacuated. Dewars have weighted base for stability. Complete with stopper.

Capacity <u>ML</u>	<u>ID. MM</u>	Neck <u>ID. MM</u>	Inside Depth <u>MM</u>	Outside Diameter <u>MM</u>	<u>Code</u>
2000	158	32	335	184	-110
5000	216	53	370	255	-111

QF-930 CADDIES FOR SPHERICAL DEWARS

Fiberglass caddies for carrying and decanting liquids from QF-920 dewar flasks.

For Flasks <u>ML</u>	<u>Code</u>
2000	-110
5000	-111



QF-940 DEWAR, WIDE MOUTH CYLINDRICAL

Borosilicate glass, silvered and evacuated. Dewars have weighted base for stability. Complete with stopper and a protective plastic mesh.

Capacity <u>ML</u>	Inside <u>Diameter, MM</u>	Inside <u>Depth, MM</u>	<u>Code</u>
350	70	125	-110
665	70	195	-111
1000	70	302	-112
1900	120	190	-113
4300	143	305	-114



FLASKS

QF-950 DEWAR, WIDE MOUTH CYLINDRICAL, WITH EXTENDED BASE

Similar to QF-940, but the aluminum base extends up to the mouth of the flask. Complete with stopper and without plastic mesh.

Capacity ML	Inside Diameter, MM	Inside Depth, MM	Code
350	70	125	-110
665	70	195	-111
1000	70	302	-112
1900	120	190	-113
4300	143	305	-114



QF-970 DEWAR, CONSTRICTED MOUTH CYLINDRICAL, WITH EXTENDED BASE

Similar to QF-960, but the aluminum base extends up to the mouth of the flask. Complete with stopper and without plastic mesh.

Capacity ML	Code
440	-110
845	-111
2250	-112

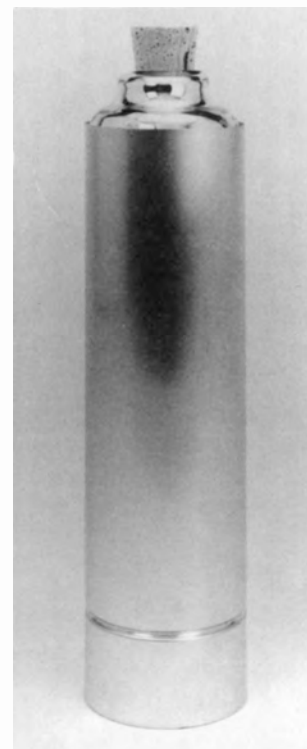

QF-960 DEWAR, CONSTRICTED MOUTH CYLINDRICAL

Similar to QF-940, but with constricted neck which affords longer holding time. Complete with stopper and a protective plastic mesh.

Capacity ML	Code
440	-110
845	-111
2250	-112



QF-980 DEWAR, POLYETHYLENE

Shatterproof and completely safe. For use with liquid nitrogen, dry ice solvent and hot baths. The chemical resistant double walls are filled with urethane foam and can withstand a temperature range from -196 to 100° C.

Capacity, ML	ID x Depth, MM	Code
1000	95 x 194	-110
2000	121 x 225	-111
4000	146 x 287	-112
10000	197 x 394	-113

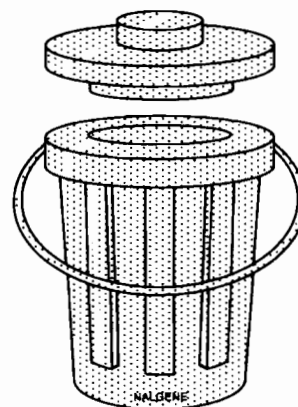

FLASKS

QF-1000 FLASK, SINGLE NECK

Round bottom with outer joint. Short neck.

Capacity	19/38	24/40	29/42	34/45	40/50	45/50	55/50	71/60
<u>ML</u>	<u>Code</u>	<u>Code</u>	<u>Code</u>	<u>Code</u>	<u>Code</u>	<u>Code</u>	<u>Code</u>	<u>Code</u>
50	-110	-219	---	---	---	---	---	---
100	-111	-220	-332	---	---	---	---	---
250	-112	-221	-333	-444	---	---	---	---
300	-113	-222	-334	-445	---	---	---	---
500	-114	-223	-335	-446	-555	-664	-773	---
1000	-115	-224	-336	-447	-556	-665	-774	---
2000	-116	-225	-337	-448	-557	-666	-775	---
3000	-117	-226	-338	-449	-558	-667	-776	-882
5000	-118	-227	-339	-450	-559	-668	-777	-883
12000	---	-228	-340	-451	-560	-669	-778	-884
22000	---	-229	-341	-452	-561	-670	-779	-885
50000	---	-230	-342	-453	-562	-671	-780	-886
72000	---	-231	-343	-454	-563	-672	-781	-887

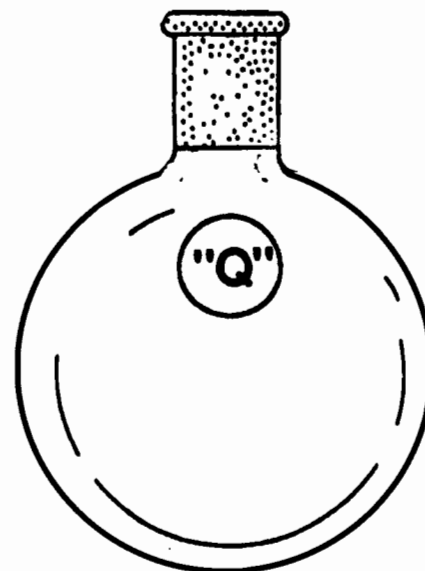

QF-1005 FLASK, SINGLE NECK

Flat bottom with outer joint. Short neck.

Capacity	19/38	24/40	29/42	34/45	40/50	45/50	55/50	71/60
<u>ML</u>	<u>Code</u>	<u>Code</u>	<u>Code</u>	<u>Code</u>	<u>Code</u>	<u>Code</u>	<u>Code</u>	<u>Code</u>
50	-110	-218	---	---	---	---	---	---
100	-111	-219	-326	---	---	---	---	---
250	-112	-220	-327	-433	---	---	---	---
300	-113	-221	-328	-434	---	---	---	---
500	-114	-222	-329	-435	-539	-643	-747	---
1000	-115	-223	-330	-436	-540	-644	-748	---
2000	-116	-224	-331	-437	-541	-645	-749	---
3000	-117	-225	-332	-438	-542	-646	-750	-851



QF-1010 FLASK, SINGLE NECK

Round bottom with outer joint. Long neck.

Capacity	19/38	24/40	29/42	34/45	40/50	45/50	55/50	71/60
<u>ML</u>	<u>Code</u>	<u>Code</u>	<u>Code</u>	<u>Code</u>	<u>Code</u>	<u>Code</u>	<u>Code</u>	<u>Code</u>
50	-110	-219	---	---	---	---	---	---
100	-111	-220	-329	---	---	---	---	---
250	-112	-221	-330	-438	---	---	---	---
300	-113	-222	-331	-439	---	---	---	---
500	-114	-223	-332	-440	-546	-652	-758	---
1000	-115	-224	-333	-441	-547	-653	-759	---
2000	-116	-225	-334	-442	-548	-654	-760	---
3000	-117	-226	-335	-443	-549	-655	-761	-864
5000	-118	-227	-336	-444	-550	-656	-762	-865
12000	---	-228	-337	-445	-551	-657	-763	-866



FLASKS

QF-1015 FLASK, SINGLE NECK

Flat bottom with outer joint. Long neck.

Capacity	19/38	24/40	29/42	34/45	40/50	45/50	55/50	71/60
ML	Code	Code	Code	Code	Code	Code	Code	Code
50	-110	-218	---	---	---	---	---	---
100	-111	-219	-326	---	---	---	---	---
250	-112	-220	-327	-433	---	---	---	---
300	-113	-221	-328	-434	---	---	---	---
500	-114	-222	-329	-435	-539	-643	-747	---
1000	-115	-223	-330	-436	-540	-644	-748	---
2000	-116	-224	-331	-437	-541	-645	-749	---
3000	-117	-225	-332	-438	-542	-646	-750	-851



QF-1020 FLASK, SINGLE NECK

Round bottom with socket joint. Short neck.

Capacity	28/15	35/25	50/30	65/40
ML	Code	Code	Code	Code
50	-110	-219	---	---
100	-111	-220	---	---
250	-112	-221	---	---
300	-113	-222	---	---
500	-114	-223	---	---
1000	-115	-224	-328	---
2000	-116	-225	-329	---
3000	-117	-226	-330	-434
5000	-118	-227	-331	-435
12000	---	---	-332	-436
22000	---	---	-333	-437

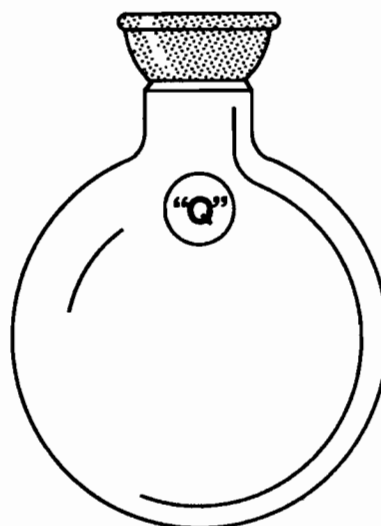

QF-1025 FLASK, SINGLE NECK

Flat bottom with socket joint. Short neck.

Capacity	28/15	35/25	50/30
ML	Code	Code	Code
50	-110	-218	---
100	-111	-219	---
250	-112	-220	---
300	-113	-221	---
500	-114	-222	---
1000	-115	-223	-326
2000	-116	-224	-327
3000	-117	-225	-328

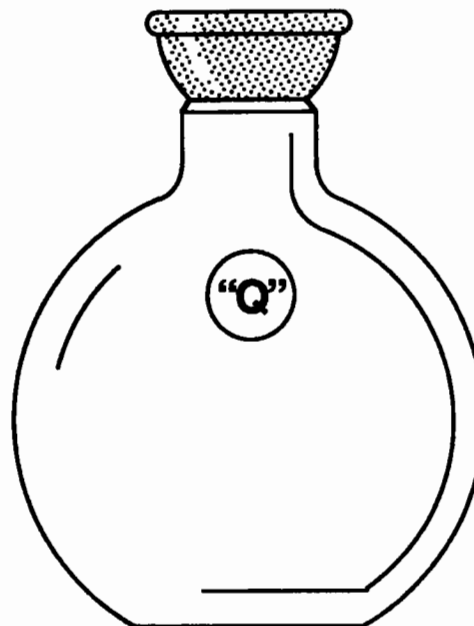

NOTE: ALL FLASKS, ROUND BOTTOM, FLAT BOTTOM, DISTILLING, BOILING, KJELDAHL, ERLLENMEYER, ETC. ARE AVAILABLE IN DIFFERENT JOINT COMBINATIONS OR NECK POSITIONS OTHER THAN THOSE LISTED IN THIS CATALOG. PLEASE CALL WITH YOUR SPECIAL REQUIREMENTS.

FLASKS

QF-1028 FLASK, QUARTZ

Single neck. Round bottom.

Capacity, ML	Joint	Code
50	19/38	-110
100	24/40	-111
250	24/40	-112
500	24/40	-113
1000	24/40	-114
1000	29/42	-115
2000	24/40	-116
2000	29/42	-117

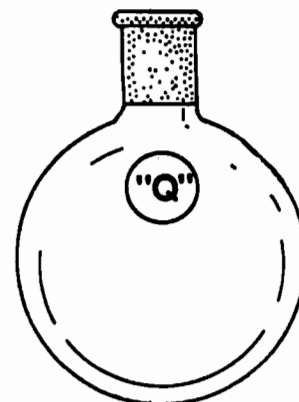

QF-1030 FLASK, DISTILLING

Round bottom with outer joint and a side inlet tube with rubber connector for an air inlet tube or thermometer.

Capacity ML	19/38 Code	24/40 Code	29/42 Code	34/45 Code	40/50 Code	45/50 Code	55/50 Code	71/60 Code
50	-110	-219	---	---	---	---	---	---
100	-111	-220	-332	---	---	---	---	---
250	-112	-221	-333	-444	---	---	---	---
300	-113	-222	-334	-445	---	---	---	---
500	-114	-223	-335	-446	-555	-664	-773	---
1000	-115	-224	-336	-447	-556	-665	-774	---
2000	-116	-225	-337	-448	-557	-666	-775	---
3000	-117	-226	-338	-449	-558	-667	-776	-882
5000	-118	-227	-339	-450	-559	-668	-777	-883
12000	---	-228	-340	-451	-560	-669	-778	-884
22000	---	-229	-341	-452	-561	-670	-779	-885
50000	---	-230	-342	-453	-562	-671	-780	-886
72000	---	-231	-343	-454	-563	-672	-781	-887

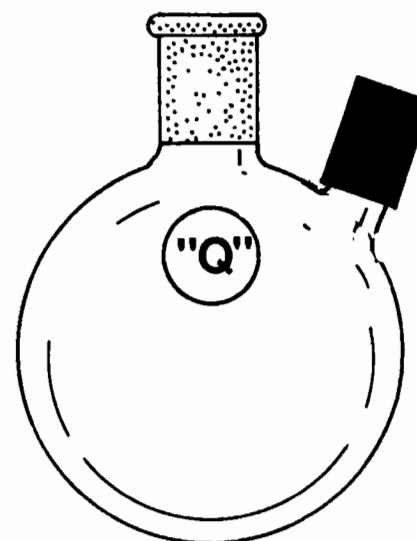

QF-1032 FLASK, DISTILLING

Round bottom. Similar to QF-1030, but with a socket joint.

Capacity ML	28/15 Code	35/25 Code	50/30 Code	65/40 Code
50	-110	-219	---	---
100	-111	-220	---	---
250	-112	-221	---	---
300	-113	-222	---	---
500	-114	-223	---	---
1000	-115	-224	-328	---
2000	-116	-225	-329	---
3000	-117	-226	-330	-434
5000	-118	-227	-331	-435
12000	---	---	-332	-436
22000	---	---	-333	-437

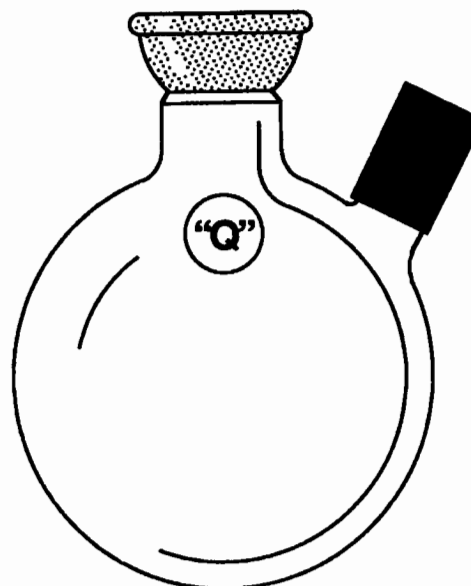

FLASKS

QF-1035 FLASK, DISTILLING

Round bottom with a full length outer joint and a side internal threaded joint with a bushing and O ring for an inlet tube or thermometer.

Capacity	19/38	24/40	29/42	34/45	40/50	45/50	55/50	71/60
ML	Code	Code	Code	Code	Code	Code	Code	Code
50	-110	-219	---	---	---	---	---	---
100	-111	-220	-332	---	---	---	---	---
250	-112	-221	-333	-444	---	---	---	---
300	-113	-222	-334	-445	---	---	---	---
500	-114	-223	-335	-446	-555	-664	-773	---
1000	-115	-224	-336	-447	-556	-665	-774	---
2000	-116	-225	-337	-448	-557	-666	-775	---
3000	-117	-226	-338	-449	-558	-667	-776	-882
5000	-118	-227	-339	-450	-559	-668	-777	-883
12000	---	-228	-340	-451	-560	-669	-778	-884
22000	---	-229	-341	-452	-561	-670	-779	-885
50000	---	-230	-342	-453	-562	-671	-780	-886
72000	---	-231	-343	-454	-563	-672	-781	-887

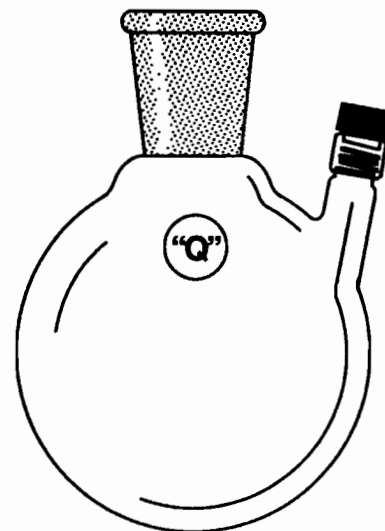

QF-1038 FLASK, DISTILLING

Round bottom. Similar to QF-1035, but with a socket joint.

Capacity, ML	28/15 Code	35/25 Code	50/30 Code	65/40 Code
50	-110	-219	---	---
100	-111	-220	---	---
250	-112	-221	---	---
300	-113	-222	---	---
500	-114	-223	---	---
1000	-115	-224	-328	---
2000	-116	-225	-329	---
3000	-117	-226	-330	-434
5000	-118	-227	-331	-435
12000	---	---	-332	-436
22000	---	---	-333	-437

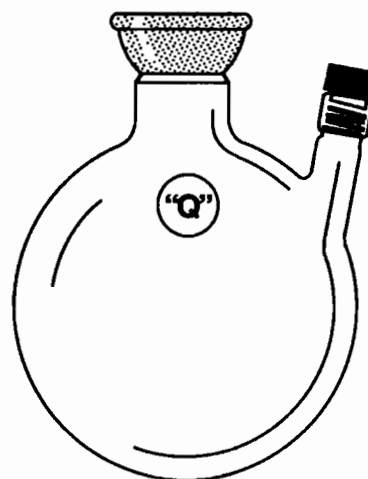

QF-1040 FLASK, DISTILLING

Round bottom with an outer joint and a side thermometer well.

Capacity	19/38	24/40	29/42	34/45	40/50	45/50	55/50	71/60
ML	Code	Code	Code	Code	Code	Code	Code	Code
50	-110	-219	---	---	---	---	---	---
100	-111	-220	-332	---	---	---	---	---
250	-112	-221	-333	-444	---	---	---	---
300	-113	-222	-334	-445	---	---	---	---
500	-114	-223	-335	-446	-555	-664	-773	---
1000	-115	-224	-336	-447	-556	-665	-774	---
2000	-116	-225	-337	-448	-557	-666	-775	---
3000	-117	-226	-338	-449	-558	-667	-776	-882
5000	-118	-227	-339	-450	-559	-668	-777	-883
12000	---	-228	-340	-451	-560	-669	-778	-884
22000	---	-229	-341	-452	-561	-670	-779	-885
50000	---	-230	-342	-453	-562	-671	-780	-886
72000	---	-231	-343	-454	-563	-672	-781	-887

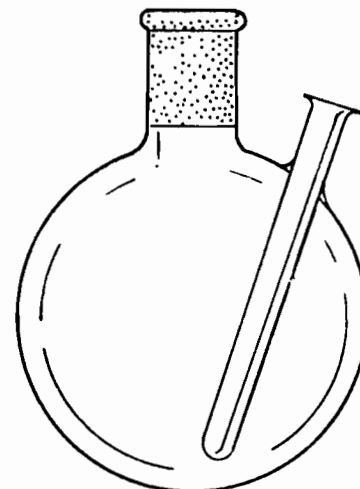

NOTE: ALL FLASKS, ROUND BOTTOM, FLAT BOTTOM, DISTILLING, BOILING, KJELDAHL, ERLIENMEYER, ETC. ARE AVAILABLE IN DIFFERENT JOINT COMBINATIONS OR NECK POSITIONS OTHER THEN THOSE LISTED IN THIS CATALOG. PLEASE CALL WITH YOUR SPECIAL REQUIREMENTS.

FLASKS

QF-1050 FLASK, DISTILLING

Round bottom. Similar to QF-1040, but with a socket joint.

Capacity	28/15	35/25	50/30	65/40
<u>ML</u>	<u>Code</u>	<u>Code</u>	<u>Code</u>	<u>Code</u>
50	-110	-219	---	---
100	-111	-220	---	---
250	-112	-221	---	---
300	-113	-222	---	---
500	-114	-223	---	---
1000	-115	-224	-328	---
2000	-116	-225	-329	---
3000	-117	-226	-330	-434
5000	-118	-227	-331	-435
12000	---	---	-332	-436
22000	---	---	-333	-437

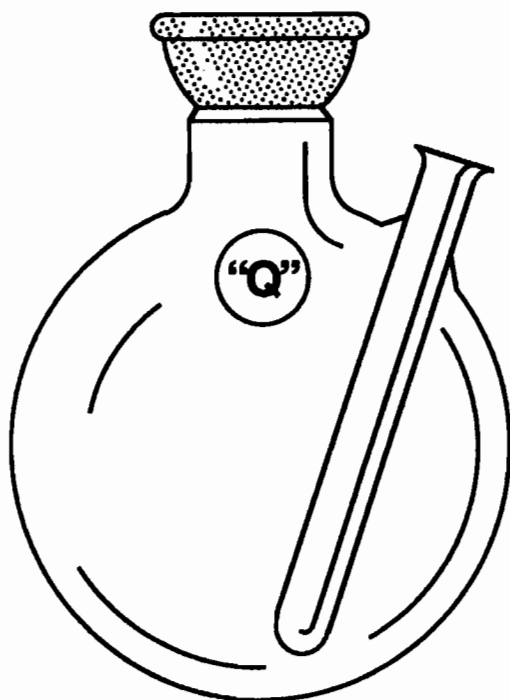

QF-1060 FLASK, 2 NECK

Round bottom with a straight side neck.

Capacity	Center	Side Necks		
		19/38	24/40	29/42
<u>ML</u>	<u>Neck</u>	<u>Code</u>	<u>Code</u>	<u>Code</u>
100	19/38	-110	---	---
100	24/40	-111	-230	---
250	19/38	-112	---	---
250	24/40	-113	-231	---
300	19/38	-114	---	---
300	24/40	-115	-232	---
500	24/40	-116	-233	---
500	29/42	-117	-234	---
1000	24/40	-118	-235	---
1000	29/42	-119	-236	-361
1000	34/45	-120	-237	-362
1000	45/50	-121	-238	-363
2000	24/40	-122	-239	---
2000	29/42	-123	-240	-364
2000	34/45	-124	-241	-365
2000	45/50	-125	-242	-366
3000	24/40	-126	-243	---
3000	29/42	-127	-244	-367
3000	34/45	-128	-245	-368
3000	45/50	-129	-246	-369
5000	24/40	---	-247	---
5000	29/42	---	-248	-370
5000	34/45	---	-249	-371
5000	45/50	---	-250	-372
12000	24/40	---	-251	---
12000	29/42	---	-252	-373
12000	34/45	---	-253	-374
12000	45/50	---	-254	-375
12000	55/50	---	-255	-376
22000	29/42	---	-256	-377
22000	34/45	---	-257	-378
22000	45/50	---	-258	-379
22000	55/50	---	-259	-380
22000	71/60	---	-260	-381

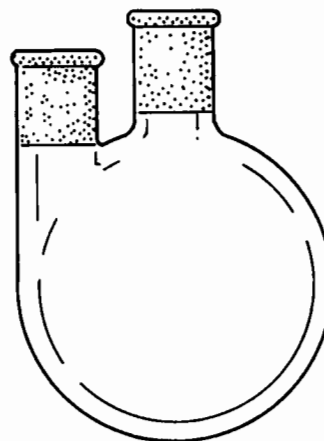

FLASKS

QF-1065 FLASK, 2 NECK

Round bottom. Similar to QF-1060, but the side neck is on an angle.

Capacity ML	Center Neck	Side Necks		
		19/38 Code	24/40 Code	29/42 Code
100	19/38	-110	---	---
100	24/40	-111	-230	---
250	19/38	-112	---	---
250	24/40	-113	-231	---
300	19/38	-114	---	---
300	24/40	-115	-232	---
500	24/40	-116	-233	---
500	29/42	-117	-234	---
1000	24/40	-118	-235	---
1000	29/42	-119	-236	-361
1000	34/45	-120	-237	-362
1000	45/50	-121	-238	-363
2000	24/40	-122	-239	---
2000	29/42	-123	-240	-364
2000	34/45	-124	-241	-365
2000	45/50	-125	-242	-366
3000	24/40	-126	-243	---
3000	29/42	-127	-244	-367
3000	34/45	-128	-245	-368
3000	45/50	-129	-246	-369
5000	24/40	---	-247	---
5000	29/42	---	-248	-370
5000	34/45	---	-249	-371
5000	45/50	---	-250	-372
12000	24/40	---	-251	---
12000	29/42	---	-252	-373
12000	34/45	---	-253	-374
12000	45/50	---	-254	-375
12000	55/50	---	-255	-376
22000	29/42	---	-256	-377
22000	34/45	---	-257	-378
22000	45/50	---	-258	-379
22000	55/50	---	-259	-380
22000	71/60	---	-260	-381

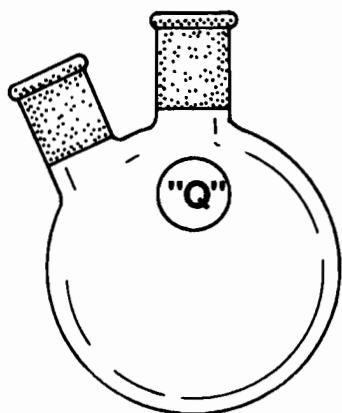

QF-1080 FLASK, 2 NECK DISTILLING

Round bottom with angled side neck and thermometer well.

Capacity ML	Center Neck	Side Necks	
		24/40 Code	29/42 Code
500	24/40	-110	---
500	29/42	-111	-238
1000	24/40	-112	---
1000	29/42	-113	-239
1000	34/45	-114	-240
1000	45/50	-115	-241
2000	24/40	-116	---
2000	29/42	-117	-242
2000	34/45	-118	-243
2000	45/50	-119	-244
3000	24/40	-120	---
3000	29/42	-121	-245
3000	34/45	-122	-246
3000	45/50	-123	-247
5000	24/40	-124	---
5000	29/42	-125	-248
5000	34/45	-126	-249
5000	45/50	-127	-250
12000	24/40	-128	---
12000	29/42	-129	-251
12000	34/45	-130	-252
12000	45/50	-131	-253
12000	55/50	-132	-254
22000	29/42	-133	-255
22000	34/45	-134	-256
22000	45/50	-135	-257
22000	55/50	-136	-258
22000	71/60	-137	-259

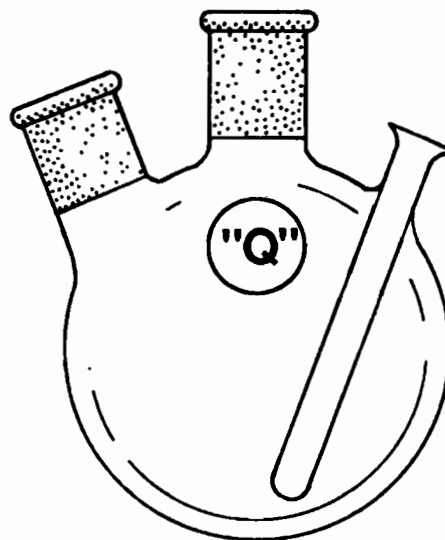

NOTE: ALL FLASKS, ROUND BOTTOM, FLAT BOTTOM, DISTILLING, BOILING, KJELDAHL, ERLIENMEYER, ETC. ARE AVAILABLE IN DIFFERENT JOINT COMBINATIONS OR NECK POSITIONS OTHER THEN THOSE LISTED IN THIS CATALOG. PLEASE CALL WITH YOUR SPECIAL REQUIREMENTS.

FLASKS

QF-2000S FLASK, 3 NECK, DISTILLING Round bottom with straight side necks.

Capacity ML	Center Neck	Side Necks							
		19/38 Code	24/40 Code	29/42 Code	34/45 Code	40/50 Code	45/50 Code	55/50 Code	71/60 Code
100	19/38	-110	---	---	---	---	---	---	---
100	24/40	-111	-233	---	---	---	---	---	---
250	19/38	-112	---	---	---	---	---	---	---
250	24/40	-113	-234	---	---	---	---	---	---
300	19/38	-114	---	---	---	---	---	---	---
300	24/40	-115	-235	---	---	---	---	---	---
500	24/40	-116	-236	---	---	---	---	---	---
500	29/42	-117	-237	-380	---	---	---	---	---
1000	24/40	-118	-238	---	---	---	---	---	---
1000	29/42	-119	-239	-381	---	---	---	---	---
1000	34/45	-120	-240	-382	-518	---	---	---	---
1000	40/50	-121	-241	-383	-519	-649	---	---	---
1000	45/50	-122	-242	-384	-520	-650	-772	---	---
2000	24/40	-123	-243	---	---	---	---	---	---
2000	29/42	-124	-244	-385	---	---	---	---	---
2000	34/45	-125	-245	-386	-521	---	---	---	---
2000	40/50	-126	-246	-387	-522	-651	---	---	---
2000	45/50	-127	-247	-388	-523	-652	-773	---	---
3000	24/40	-128	-248	---	---	---	---	---	---
3000	29/42	-129	-249	-389	---	---	---	---	---
3000	34/45	-130	-250	-390	-524	---	---	---	---
3000	40/50	-131	-251	-391	-525	-653	---	---	---
3000	45/50	-132	-252	-392	-526	-654	-774	---	---
5000	24/40	---	-253	---	---	---	---	---	---
5000	29/42	---	-254	-393	---	---	---	---	---
5000	34/45	---	-255	-394	-527	---	---	---	---
5000	40/50	---	-256	-395	-528	-655	---	---	---
5000	45/50	---	-257	-396	-529	-656	-775	---	---
12000	24/40	---	-258	---	---	---	---	---	---
12000	29/42	---	-259	-397	---	---	---	---	---
12000	34/45	---	-260	-398	-530	---	---	---	---
12000	40/50	---	-261	-399	-531	-657	---	---	---
12000	45/50	---	-262	-400	-532	-658	-776	---	---
12000	55/50	---	-263	-401	-533	-659	-777	-887	---
22000	29/42	---	-264	-402	---	---	---	---	---
22000	34/45	---	-265	-403	-534	---	---	---	---
22000	40/50	---	-266	-404	-535	-660	---	---	---
22000	45/50	---	-267	-405	-536	-661	-778	---	---
22000	55/50	---	-268	-406	-537	-662	-779	-888	---
22000	71/60	---	-269	-407	-538	-663	-780	-889	-994
50000	34/45	---	-270	-408	-539	---	---	---	---
50000	40/50	---	-271	-409	-540	-664	---	---	---
50000	45/50	---	-272	-410	-541	-665	-781	---	---
50000	55/50	---	-273	-411	-542	-666	-782	-890	---
50000	71/60	---	-274	-412	-543	-667	-783	-891	-995
72000	34/45	---	-275	-413	-544	---	---	---	---
72000	40/50	---	-276	-414	-545	-668	---	---	---
72000	45/50	---	-277	-415	-546	-669	-784	---	---
72000	55/50	---	-278	-416	-547	-670	-785	-892	---
72000	71/60	---	-279	-417	-548	-671	-786	-893	-996

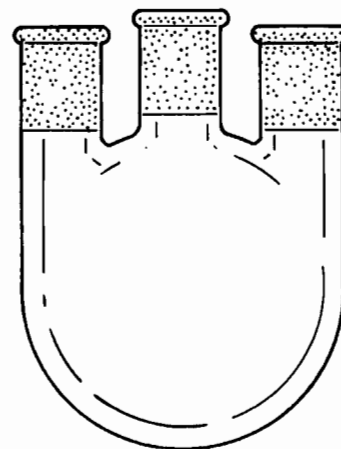

FLASKS

QF-2000A FLASK, 3 NECK, DISTILLING Round bottom with angled side necks.

Capacity ML	Center Neck	Side Necks							
		19/38 Code	24/40 Code	29/42 Code	34/45 Code	40/50 Code	45/50 Code	55/50 Code	71/60 Code
100	19/38	-110	---	---	---	---	---	---	---
100	24/40	-111	-233	---	---	---	---	---	---
250	19/38	-112	---	---	---	---	---	---	---
250	24/40	-113	-234	---	---	---	---	---	---
300	19/38	-114	---	---	---	---	---	---	---
300	24/40	-115	-235	---	---	---	---	---	---
500	24/40	-116	-236	---	---	---	---	---	---
500	29/42	-117	-237	-380	---	---	---	---	---
1000	24/40	-118	-238	---	---	---	---	---	---
1000	29/42	-119	-239	-381	---	---	---	---	---
1000	34/45	-120	-240	-382	-518	---	---	---	---
1000	40/50	-121	-241	-383	-519	-649	---	---	---
1000	45/50	-122	-242	-384	-520	-650	-772	---	---
2000	24/40	-123	-243	---	---	---	---	---	---
2000	29/42	-124	-244	-385	---	---	---	---	---
2000	34/45	-125	-245	-386	-521	---	---	---	---
2000	40/50	-126	-246	-387	-522	-651	---	---	---
2000	45/50	-127	-247	-388	-523	-652	-773	---	---
3000	24/40	-128	-248	---	---	---	---	---	---
3000	29/42	-129	-249	-389	---	---	---	---	---
3000	34/45	-130	-250	-390	-524	---	---	---	---
3000	40/50	-131	-251	-391	-525	-653	---	---	---
3000	45/50	-132	-252	-392	-526	-654	-774	---	---
5000	24/40	---	-253	---	---	---	---	---	---
5000	29/42	---	-254	-393	---	---	---	---	---
5000	34/45	---	-255	-394	-527	---	---	---	---
5000	40/50	---	-256	-395	-528	-655	---	---	---
5000	45/50	---	-257	-396	-529	-656	-775	---	---
12000	24/40	---	-258	---	---	---	---	---	---
12000	29/42	---	-259	-397	---	---	---	---	---
12000	34/45	---	-260	-398	-530	---	---	---	---
12000	40/50	---	-261	-399	-531	-657	---	---	---
12000	45/50	---	-262	-400	-532	-658	-776	---	---
12000	55/50	---	-263	-401	-533	-659	-777	-887	---
22000	29/42	---	-264	-402	---	---	---	---	---
22000	34/45	---	-265	-403	-534	---	---	---	---
22000	40/50	---	-266	-404	-535	-660	---	---	---
22000	45/50	---	-267	-405	-536	-661	-778	---	---
22000	55/50	---	-268	-406	-537	-662	-779	-888	---
22000	71/60	---	-269	-407	-538	-663	-780	-889	-994
50000	34/45	---	-270	-408	-539	---	---	---	---
50000	40/50	---	-271	-409	-540	-664	---	---	---
50000	45/50	---	-272	-410	-541	-665	-781	---	---
50000	55/50	---	-273	-411	-542	-666	-782	-890	---
50000	71/60	---	-274	-412	-543	-667	-783	-891	-995
72000	34/45	---	-275	-413	-544	---	---	---	---
72000	40/50	---	-276	-414	-545	-668	---	---	---
72000	45/50	---	-277	-415	-546	-669	-784	---	---
72000	55/50	---	-278	-416	-547	-670	-785	-892	---
72000	71/60	---	-279	-417	-548	-671	-786	-893	-996

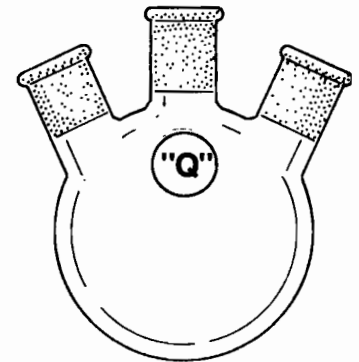

NOTE: ALL FLASKS, ROUND BOTTOM, FLAT BOTTOM, DISTILLING, BOILING, KJELDAHL, ERLIENMEYER, ETC. ARE AVAILABLE IN DIFFERENT JOINT COMBINATIONS OR NECK POSITIONS OTHER THEN THOSE LISTED IN THIS CATALOG. PLEASE CALL WITH YOUR SPECIAL REQUIREMENTS.

FLASKS

QF-2010 FLASK, 3 NECK DISTILLING

Round bottom with socket joints
and straight side necks.

Capacity ML	Center Neck	Side Necks			
		28/15 Code	35/25 Code	50/30 Code	65/40 Code
250	35/25	-110	-217	---	---
500	35/25	-111	-218	---	---
1000	35/25	-112	-219	---	---
2000	35/25	-113	-220	---	---
3000	35/25	-114	-221	---	---
3000	50/30	-115	-222	---	---
5000	35/25	-116	-223	---	---
5000	50/30	---	-224	-333	---
5000	65/40	---	-225	-334	-441
12000	35/25	---	-226	---	---
12000	50/30	---	-227	-335	---
12000	65/40	---	-228	-336	-442
12000	102/75	---	-229	-337	-443
22000	50/30	---	-230	-338	---
22000	65/40	---	-231	-339	-444
22000	102/75	---	-232	-340	-445

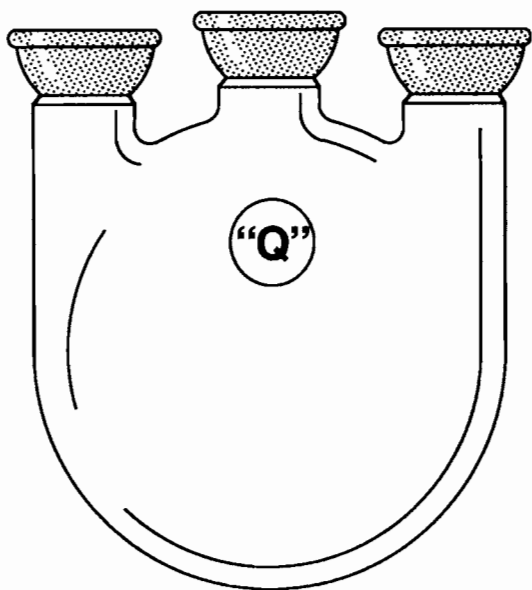

QF-2012 FLASK, 3 NECK DISTILLING

Round bottom with socket joints
and angled side necks.

Capacity ML	Center Neck	Side Necks			
		28/15 Code	35/25 Code	50/30 Code	65/40 Code
250	35/25	-110	-217	---	---
500	35/25	-111	-218	---	---
1000	35/25	-112	-219	---	---
2000	35/25	-113	-220	---	---
3000	35/25	-114	-221	---	---
3000	50/30	-115	-222	---	---
5000	35/25	-116	-223	---	---
5000	50/30	---	-224	-333	---
5000	65/40	---	-225	-334	-441
12000	35/25	---	-226	---	---
12000	50/30	---	-227	-335	---
12000	65/40	---	-228	-336	-442
12000	102/75	---	-229	-337	-443
22000	50/30	---	-230	-338	---
22000	65/40	---	-231	-339	-444
22000	102/75	---	-232	-340	-445

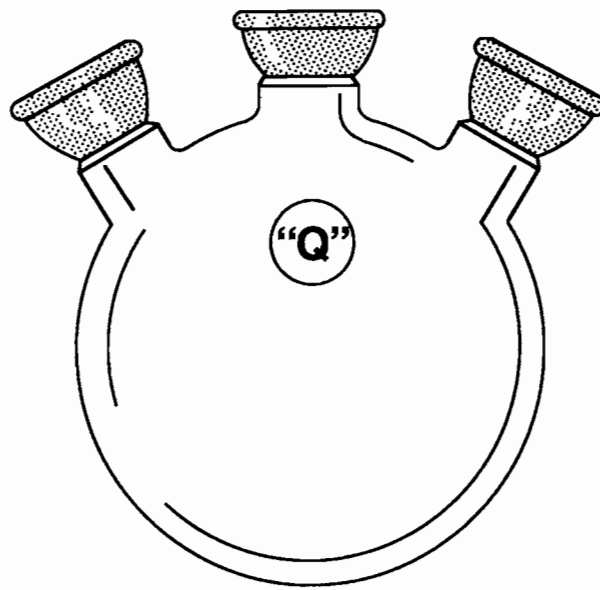

FLASKS

QF-2015 FLASK, 3 NECK DISTILLING

Round bottom with 3 straight necks and a 10/30 outer joint for a thermometer or gas inlet.

Capacity ML	Center Neck	Side Necks	
		24/40 Code	29/42 Code
250	24/40	-110	---
500	24/40	-111	---
500	29/42	-112	-237
1000	24/40	-113	---
1000	29/42	-114	-238
1000	34/45	-115	-239
2000	24/40	-116	---
2000	29/42	-117	-240
2000	34/45	-118	-241
2000	45/50	-119	-242
3000	24/40	-120	---
3000	29/42	-121	-243
3000	34/45	-122	-244
3000	45/50	-123	-245
5000	24/40	-124	---
5000	29/42	-125	-246
5000	34/45	-126	-247
5000	45/50	-127	-248
12000	24/40	-128	---
12000	29/42	-129	-249
12000	34/45	-130	-250
12000	45/50	-131	-251
12000	55/50	-132	-252
22000	29/42	-133	-253
22000	34/45	-134	-254
22000	45/50	-135	-255
22000	55/50	-136	-256

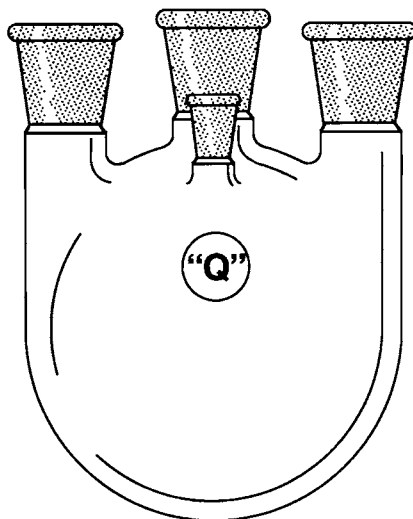

QF-2018 FLASK, 3 NECK DISTILLING

Round bottom with 3 straight necks and an internal threaded joint with bushing and O ring for a thermometer or gas inlet.

Capacity ML	Center Neck	Side Necks	
		24/40 Code	29/42 Code
250	24/40	-110	---
500	24/40	-111	---
500	29/42	-112	-237
1000	24/40	-113	---
1000	29/42	-114	-238
1000	34/45	-115	-239
2000	24/40	-116	---
2000	29/42	-117	-240
2000	34/45	-118	-241
2000	45/50	-119	-242
3000	24/40	-120	---
3000	29/42	-121	-243
3000	34/45	-122	-244
3000	45/50	-123	-245
5000	24/40	-124	---
5000	29/42	-125	-246
5000	34/45	-126	-247
5000	45/50	-127	-248
12000	24/40	-128	---
12000	29/42	-129	-249
12000	34/45	-130	-250
12000	45/50	-131	-251
12000	55/50	-132	-252
22000	29/42	-133	-253
22000	34/45	-134	-254
22000	45/50	-135	-255
22000	55/50	-136	-256

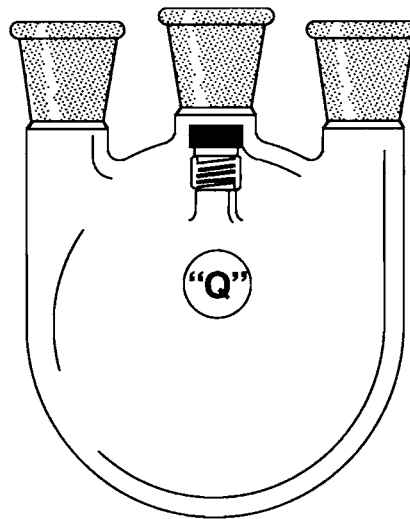

NOTE: ALL FLASKS, ROUND BOTTOM, FLAT BOTTOM, DISTILLING, BOILING, KJELDAHL, ERLLENMEYER, ETC. ARE AVAILABLE IN DIFFERENT JOINT COMBINATIONS OR NECK POSITIONS OTHER THEN THOSE LISTED IN THIS CATALOG. PLEASE CALL WITH YOUR SPECIAL REQUIREMENTS.

FLASKS

QF-2020 FLASK, 3 NECK DISTILLING

Round bottom with 3 straight necks
and a side thermometer well.

Capacity ML	Center Neck	Side Necks	
		24/40 Code	29/42 Code
250	24/40	-110	---
500	24/40	-111	---
500	29/42	-112	-237
1000	24/40	-113	---
1000	29/42	-114	-238
1000	34/45	-115	-239
2000	24/40	-116	---
2000	29/42	-117	-240
2000	34/45	-118	-241
2000	45/50	-119	-242
3000	24/40	-120	---
3000	29/42	-121	-243
3000	34/45	-122	-244
3000	45/50	-123	-245
5000	24/40	-124	---
5000	29/42	-125	-246
5000	34/45	-126	-247
5000	45/50	-127	-248
12000	24/40	-128	---
12000	29/42	-129	-249
12000	34/45	-130	-250
12000	45/50	-131	-251
12000	55/50	-132	-252
22000	29/42	-133	-253
22000	34/45	-134	-254
22000	45/50	-135	-255
22000	55/50	-136	-256

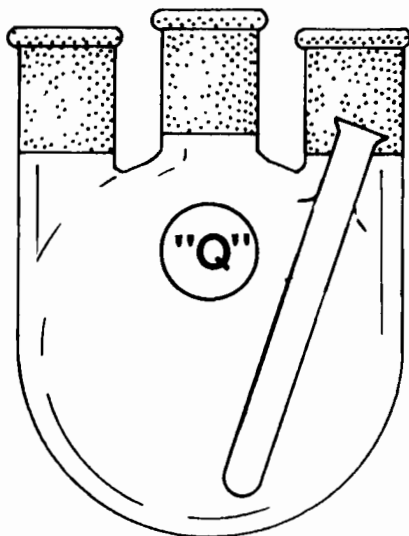

REMEMBER

"Q" Glass has been working
with customers to design and
build custom glass apparatus
and component parts since
1946. We can do the same
for you. Please write or call us
with your special requirements.

FLASKS

QF-2040 FLASK, 4 NECK, DISTILLING Round bottom with straight side necks.

Capacity ML	Center Neck	Side Necks							
		19/38 Code	24/40 Code	29/42 Code	34/45 Code	40/50 Code	45/50 Code	55/50 Code	71/60 Code
500	24/40	-110	-227	---	---	---	---	---	---
500	29/42	-111	-228	-371	---	---	---	---	---
1000	24/40	-112	-229	---	---	---	---	---	---
1000	29/42	-113	-230	-372	---	---	---	---	---
1000	34/45	-114	-231	-373	-509	---	---	---	---
1000	40/50	-115	-232	-374	-510	-640	---	---	---
1000	45/50	-116	-233	-375	-511	-641	-763	---	---
2000	24/40	-117	-234	---	---	---	---	---	---
2000	29/42	-118	-235	-376	---	---	---	---	---
2000	34/45	-119	-236	-377	-512	---	---	---	---
2000	40/50	-120	-237	-378	-513	-642	---	---	---
2000	45/50	-121	-238	-379	-514	-643	-764	---	---
3000	24/40	-122	-239	---	---	---	---	---	---
3000	29/42	-123	-240	-380	---	---	---	---	---
3000	34/45	-124	-241	-381	-515	---	---	---	---
3000	40/50	-125	-242	-382	-516	-644	---	---	---
3000	45/50	-126	-243	-383	-517	-645	-765	---	---
5000	24/40	---	-244	---	---	---	---	---	---
5000	29/42	---	-245	-384	---	---	---	---	---
5000	34/45	---	-246	-385	-518	---	---	---	---
5000	40/50	---	-247	-386	-519	-646	---	---	---
5000	45/50	---	-248	-387	-520	-647	-766	---	---
12000	24/40	---	-249	---	---	---	---	---	---
12000	29/42	---	-250	-388	---	---	---	---	---
12000	34/45	---	-251	-389	-521	---	---	---	---
12000	40/50	---	-252	-390	-522	-648	---	---	---
12000	45/50	---	-253	-391	-523	-649	-767	---	---
12000	55/50	---	-254	-392	-524	-650	-768	-878	---
22000	29/42	---	-255	-393	---	---	---	---	---
22000	34/45	---	-256	-394	-525	---	---	---	---
22000	40/50	---	-257	-395	-526	-651	---	---	---
22000	45/50	---	-258	-396	-527	-652	-769	---	---
22000	55/50	---	-259	-397	-528	-653	-770	-879	---
22000	71/60	---	-260	-398	-529	-654	-771	-880	-985
50000	34/45	---	-261	-399	-530	---	---	---	---
50000	40/50	---	-262	-400	-531	-655	---	---	---
50000	45/50	---	-263	-401	-532	-656	-772	---	---
50000	55/50	---	-264	-402	-533	-657	-773	-881	---
50000	71/60	---	-265	-403	-534	-658	-774	-882	-986
72000	34/45	---	-266	-404	-535	---	---	---	---
72000	40/50	---	-267	-405	-536	-659	---	---	---
72000	45/50	---	-268	-406	-537	-660	-775	---	---
72000	55/50	---	-269	-407	-538	-661	-776	-883	---
72000	71/60	---	-270	-408	-539	-662	-777	-884	-987

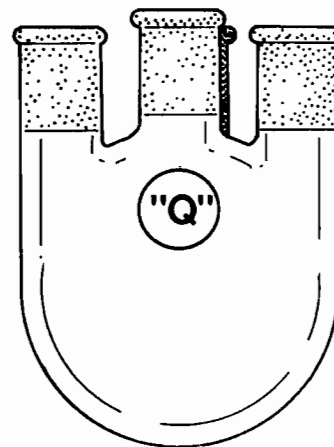

NOTE: ALL FLASKS, ROUND BOTTOM, FLAT BOTTOM, DISTILLING, BOILING, KJELDAHL, ERLLENMEYER, ETC. ARE AVAILABLE IN DIFFERENT JOINT COMBINATIONS OR NECK POSITIONS OTHER THAN THOSE LISTED IN THIS CATALOG. PLEASE CALL WITH YOUR SPECIAL REQUIREMENTS.

FLASKS

QF-2060 FLASK, 5 NECK, DISTILLING Round bottom with straight side necks.

Capacity ML	Center Neck	Side Necks							
		19/38 Code	24/40 Code	29/42 Code	34/45 Code	40/50 Code	45/50 Code	55/50 Code	71/60 Code
500	24/40	-110	-227	---	---	---	---	---	---
500	29/42	-111	-228	-371	---	---	---	---	---
1000	24/40	-112	-229	---	---	---	---	---	---
1000	29/42	-113	-230	-372	---	---	---	---	---
1000	34/45	-114	-231	-373	-509	---	---	---	---
1000	40/50	-115	-232	-374	-510	-640	---	---	---
1000	45/50	-116	-233	-375	-511	-641	-763	---	---
2000	24/40	-117	-234	---	---	---	---	---	---
2000	29/42	-118	-235	-376	---	---	---	---	---
2000	34/45	-119	-236	-377	-512	---	---	---	---
2000	40/50	-120	-237	-378	-513	-642	---	---	---
2000	45/50	-121	-238	-379	-514	-643	-764	---	---
3000	24/40	-122	-239	---	---	---	---	---	---
3000	29/42	-123	-240	-380	---	---	---	---	---
3000	34/45	-124	-241	-381	-515	---	---	---	---
3000	40/50	-125	-242	-382	-516	-644	---	---	---
3000	45/50	-126	-243	-383	-517	-645	-765	---	---
5000	24/40	---	-244	---	---	---	---	---	---
5000	29/42	---	-245	-384	---	---	---	---	---
5000	34/45	---	-246	-385	-518	---	---	---	---
5000	40/50	---	-247	-386	-519	-646	---	---	---
5000	45/50	---	-248	-387	-520	-647	-766	---	---
12000	24/40	---	-249	---	---	---	---	---	---
12000	29/42	---	-250	-388	---	---	---	---	---
12000	34/45	---	-251	-389	-521	---	---	---	---
12000	40/50	---	-252	-390	-522	-648	---	---	---
12000	45/50	---	-253	-391	-523	-649	-767	---	---
12000	55/50	---	-254	-392	-524	-650	-768	-878	---
22000	29/42	---	-255	-393	---	---	---	---	---
22000	34/45	---	-256	-394	-525	---	---	---	---
22000	40/50	---	-257	-395	-526	-651	---	---	---
22000	45/50	---	-258	-396	-527	-652	-769	---	---
22000	55/50	---	-259	-397	-528	-653	-770	-879	---
22000	71/60	---	-260	-398	-529	-654	-771	-880	-985
50000	34/45	---	-261	-399	-530	---	---	---	---
50000	40/50	---	-262	-400	-531	-655	---	---	---
50000	45/50	---	-263	-401	-532	-656	-772	---	---
50000	55/50	---	-264	-402	-533	-657	-773	-881	---
50000	71/60	---	-265	-403	-534	-658	-774	-882	-986
72000	34/45	---	-266	-404	-535	---	---	---	---
72000	40/50	---	-267	-405	-536	-659	---	---	---
72000	45/50	---	-268	-406	-537	-660	-775	---	---
72000	55/50	---	-269	-407	-538	-661	-776	-883	---
72000	71/60	---	-270	-408	-539	-662	-777	-884	-987

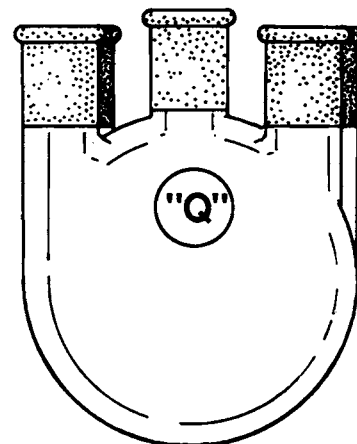

FLASKS

QF-2080 FLASK, JACKETED DISTILLING

3 neck. The lower half of the flask is jacketed, with inlet and outlet hose connections and a glass stopcock at the bottom.

Capacity ML	Center Neck	Stopcock Bore, MM	Side Necks	
			24/40 Code	29/42 Code
500	24/40	4	-110	---
500	29/42	4	-111	-229
1000	24/40	4	-112	---
1000	29/42	4	-113	-230
2000	24/40	4	-114	---
2000	29/42	4	-115	-231
2000	34/45	4	-116	-232
3000	24/40	4	-117	---
3000	29/42	4	-118	-233
3000	34/45	4	-119	-234
3000	45/50	4	-120	-235
5000	24/40	4	-121	---
5000	29/42	4	-122	-236
5000	34/45	4	-123	-237
5000	45/50	4	-124	-238
12000	29/42	6	-125	-239
12000	34/45	6	-126	-240
12000	45/50	6	-127	-241
12000	55/50	6	-128	-242

QF-2090 FLASK, JACKETED DISTILLING

3 neck. Similar to QF-2080, but with a teflon stopcock.

Capacity ML	Center Neck	Stopcock Bore, MM	Side Necks	
			24/40 Code	29/42 Code
500	24/40	4	-110	---
500	29/42	4	-111	-229
1000	24/40	4	-112	---
1000	29/42	4	-113	-230
2000	24/40	4	-114	---
2000	29/42	4	-115	-231
2000	34/45	4	-116	-232
3000	24/40	4	-117	---
3000	29/42	4	-118	-233
3000	34/45	4	-119	-234
3000	45/50	4	-120	-235
5000	24/40	4	-121	---
5000	29/42	4	-122	-236
5000	34/45	4	-123	-237
5000	45/50	4	-124	-238
12000	29/42	6	-125	-239
12000	34/45	6	-126	-240
12000	45/50	6	-127	-241
12000	55/50	6	-128	-242

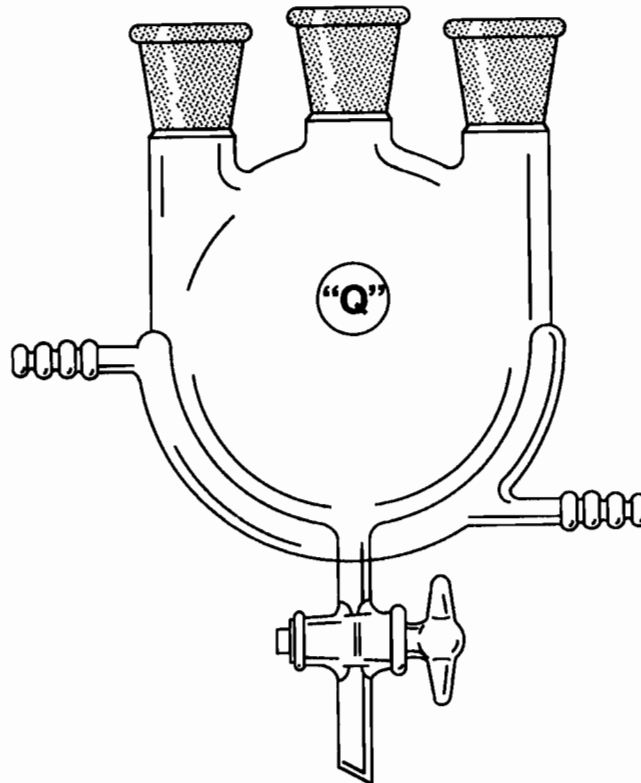

NOTE: ALL FLASKS, ROUND BOTTOM, FLAT BOTTOM, DISTILLING, BOILING, KJELDAHL, ERLLENMEYER, ETC. ARE AVAILABLE IN DIFFERENT JOINT COMBINATIONS OR NECK POSITIONS OTHER THEN THOSE LISTED IN THIS CATALOG. PLEASE CALL WITH YOUR SPECIAL REQUIREMENTS.

FLASKS

QF-3000 FLASK, JACKETED DISTILLING

3 neck. The entire flask is jacketed, with inlet and outlet hose connections.

Capacity ML	Center Neck	Side Necks	
		24/40 Code	29/42 Code
500	24/40	-110	---
500	29/42	-111	-225
1000	24/40	-112	---
1000	29/42	-113	-226
2000	24/40	-114	---
2000	29/42	-115	-227
2000	34/45	-116	-228
3000	24/40	-117	---
3000	29/42	-118	-229
3000	34/45	-119	-230
3000	45/50	-120	-231
5000	24/40	-121	---
5000	29/42	-122	-232
5000	34/45	-123	-233
5000	45/50	-124	-234

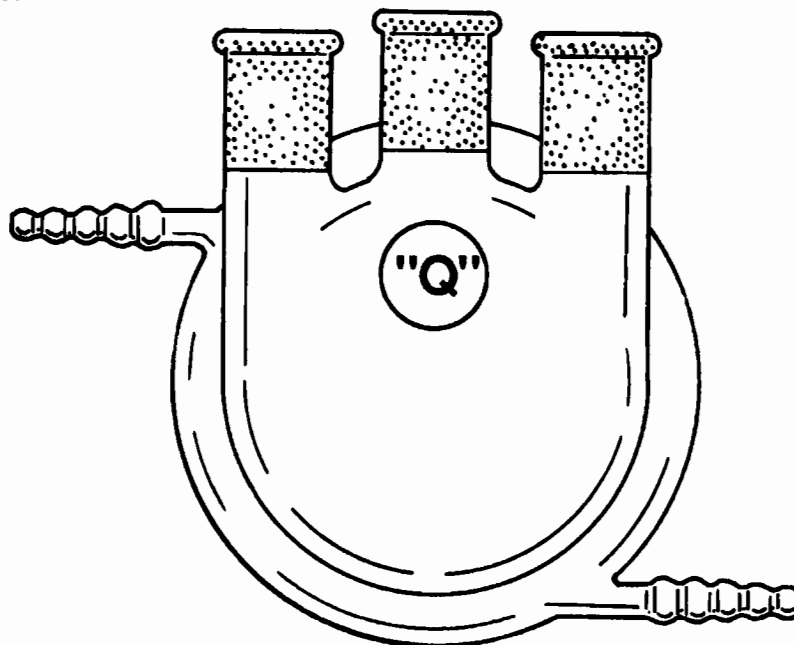

QF-3020 FLASK, DISTILLING

3 neck, with a stopcock on the bottom for delivery. Available with a glass or teflon stopcock.

Capacity ML	Stopcock Bore MM	Center Neck	Glass Stopcock Side Neck		Teflon Stopcock Side Neck	
			24/40 Code	29/42 Code	24/40 Code	29/42 Code
500	4	24/40	-110	---	-335	---
500	4	29/42	-111	-225	-336	-450
1000	4	24/40	-112	---	-337	---
1000	4	29/42	-113	-226	-338	-451
2000	4	24/40	-114	---	-339	---
2000	4	29/42	-115	-227	-340	-452
2000	4	45/50	-116	-228	-341	-453
3000	4	24/40	-117	---	-342	---
3000	4	29/42	-118	-229	-343	-454
3000	4	45/50	-119	-230	-344	-455
5000	4	24/40	-120	---	-345	---
5000	4	29/42	-121	-231	-346	-456
5000	4	45/50	-122	-232	-347	-457
12000	6	45/50	-123	-233	-348	-458
22000	8	45/50	-124	-234	-349	-459

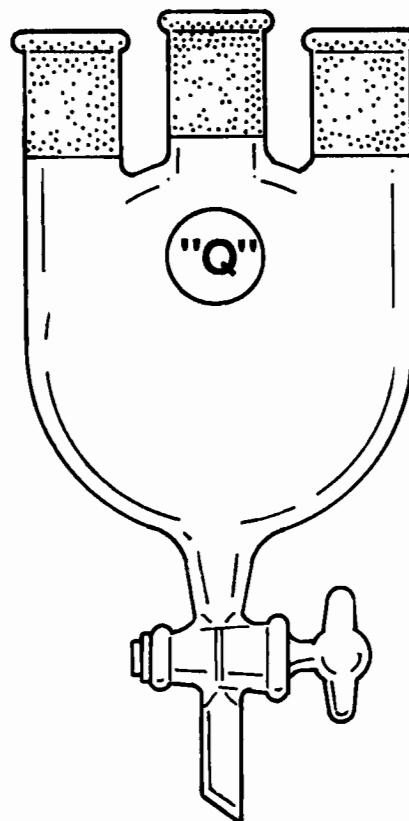

FLASKS

QF-3025 FLASK, DISTILLING

Flat bottom with side arm for general purpose batch distillation. Side arm has a 19/38 inner joint.

Capacity ML	Neck Stopper	Code
500	22	-110
1000	27	-111

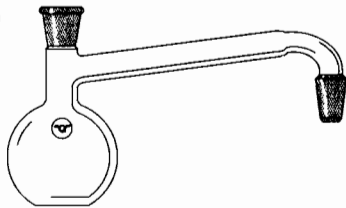

QF-3040 FLASK, ERLLENMEYER

With outer joint.

Capacity ML	24/40 Code	29/42 Code	34/45 Code	45/50 Code
50	-110	-219	---	---
125	-111	-220	---	---
250	-112	-221	-328	---
300	-113	-222	-329	---
500	-114	-223	-330	-435
1000	-115	-224	-331	-436
2000	-116	-225	-332	-437
4000	-117	-226	-333	-438
6000	-118	-227	-334	-439

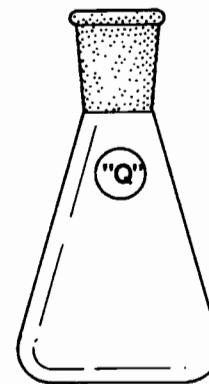

QF-3030 FLASK, DISTILLING

Round bottom with tooled reinforced top for rubber stopper and side arm. ASTM test methods D-86, D-447 and E-133.

Capacity ML	Code
100	-110
200	-111
250	-112

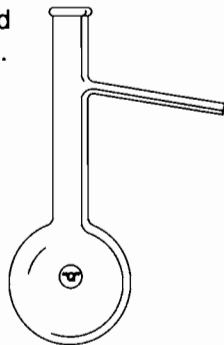

QF-3035 FLASK, DISTILLING

Round bottom, 250ml with tooled reinforced top for rubber stopper. A side delivery tube from curved neck is bent down.

Code
-110

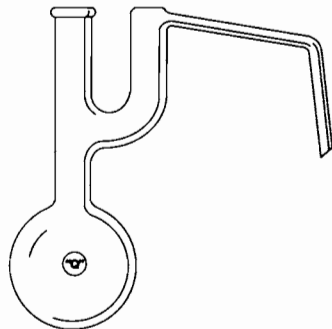

QF-3050 FLASK, ERLLENMEYER

With socket joint.

Capacity ML	28/15 Code	35/25 Code	50/30 Code
125	-110	---	---
250	-111	-214	---
300	-112	-215	---
500	-113	-216	-321
1000	---	-217	-322
2000	---	-218	-323
4000	---	-219	-324
6000	---	-220	-325

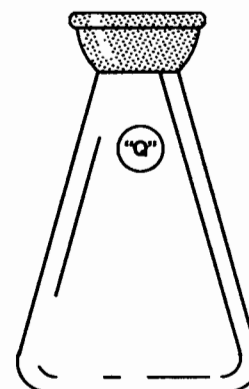

REMEMBER

“Q” Glass has been working with customers to design and build custom glass apparatus and component parts since 1946. We can do the same for you. Please write or call us with your special requirements.

FLASKS

QF-3055 FLASK, ERLENMEYER POLYCARBONATE

With polypropylene closure. Autoclavable.

Capacity ML	Pack Code	Case Code
25	6/-110	24/-216
50	6/-111	24/-217
125	6/-112	24/-218
250	4/-113	12/-219
500	4/-114	12/-220
1000	2/-115	6/-221

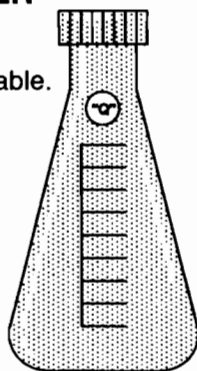

QF-3076 FLASK, FILTERING POLYPROPYLENE

Molded in one piece with hose connection on a 45° angle. Autoclavable.

Capacity ML	Rubber Stopper Size	Code
500	7	-110
1000	8	-111

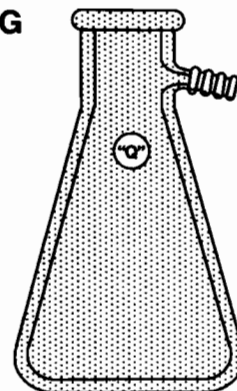

QF-3060 FLASK, QUARTZ

With outer joint.

Capacity ML	Joint Size	Code
125	24/40	-110
250	24/40	-111
500	24/40	-112
1000	29/42	-113
2000	29/42	-114



QF-3078 FLASK, FILTERING

Erlenmeyer with an outer joint and a 2mm side stopcock. Available with a glass or teflon stopcock.

Capacity ML	Glass Stopcock			Teflon Stopcock		
	24/40 Code	29/42 Code	45/50 Code	24/40 Code	29/42 Code	45/50 Code
250	-110	-214	---	-421	-525	---
500	-111	-215	-318	-422	-526	-629
1000	-112	-216	-319	-423	-527	-630
2000	-113	-217	-320	-424	-528	-631

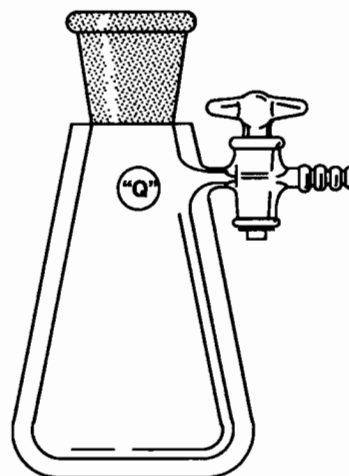

QF-3070 FLASK, FILTERING

Extra heavy wall erlenmeyer with outer joint.

Capacity ML	24/40 Code	29/42 Code	34/45 Code	45/50 Code
125	-110	-216	---	---
250	-111	-217	-322	---
500	-112	-218	-323	-427
1000	-113	-219	-324	-428
2000	-114	-220	-325	-429
4000	-115	-221	-326	-430



QF-3075 FLASK, FILTERING

Extra heavy wall erlenmeyer with hose connection for vacuum and outer joint.

Capacity ML	24/40 Code	29/42 Code	34/45 Code	45/50 Code
125	-110	-216	---	---
250	-111	-217	-322	---
500	-112	-218	-323	-427
1000	-113	-219	-324	-428
2000	-114	-220	-325	-429
4000	-115	-221	-326	-430

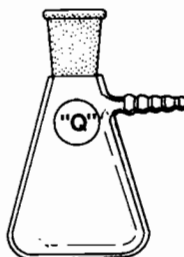

QF-3079 FLASK, FILTERING

Extra heavy wall erlenmeyer with tooled reinforced top for rubber stopper.

Capacity ML	Rubber Stopper Size	Code
125	6	-110
250	8	-111
500	8	-112
1000	10	-113
2000	12	-114



FLASKS

QF-3080 FLASK, FILTERING

Extra heavy wall erlenmeyer. Similar to QF-3079, but with the addition of a hose connection for vacuum.

Capacity ML	Rubber Stopper Size	Code
125	6	-110
250	8	-111
500	8	-112
1000	10	-113
2000	12	-114

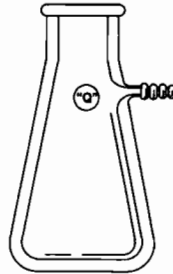

QF-3090 FLASK, KJELDAHL

Long neck kjeldahl with an outer joint.

Capacity ML	19/38 Code	24/40 Code	29/42 Code	34/45 Code
100	-110	-215	-320	-425
300	-111	-216	-321	-426
500	-112	-217	-322	-427
650	-113	-218	-323	-428
800	-114	-219	-324	-429

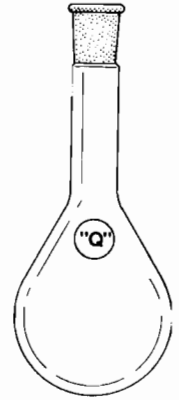

QF-3082 DURAN FLASK, FILTERING

Extra heavy wall erlenmeyer. Similar to QF-3080, but with a removable PPN hose connection which is secured to the flask with a silicone rubber seal. For hose connection sets see QB-1055.

Capacity ML	O.D. MM	Height MM	Neck I.D., MM	Code
100	65	100	24	-110
250	85	155	34.5	-111
500	105	185	34.5	-112
1000	135	230	45	-113
2000	166	265	60	-114

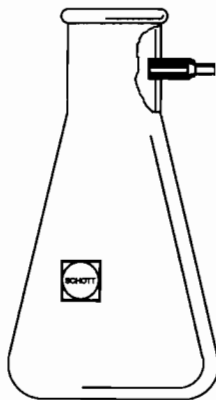

QF-4000 FLASK, RECOVERY

With outer joint. The shape allows easier recovery of solids or liquids.

Capacity ML	24/25 Code	24/40 Code	29/26 Code	29/42 Code
10	---	-216	---	---
25	---	-217	---	---
50	-110	-218	-324	-430
100	-111	-219	-325	-431
200	-112	-220	-326	-432
500	-113	-221	-327	-433
1000	-114	-222	-328	-434
2000	-115	-223	-329	-435



QF-3085 FLASK, IODINE

Flasks have a 24/40 outer joint with stopper. The handle extends above the liquid seal. Used in ASTM test methods D-29, D-234-58T and D-260.

Capacity ML	Complete Code	Flask Only Code
125	-110	-214
250	-111	-215
500	-112	-216
1000	-113	-217

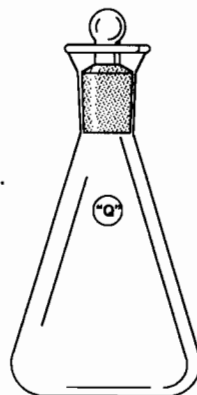

QF-4010 FLASK, MORTON TYPE

Single neck outer joint with four indentations for improved stirring.

Capacity ML	19/38 Code	24/40 Code	29/42 Code	34/45 Code
500	-110	-215	-320	---
1000	-111	-216	-321	-425
2000	-112	-217	-322	-426
3000	-113	-218	-323	-427
5000	-114	-219	-324	-428

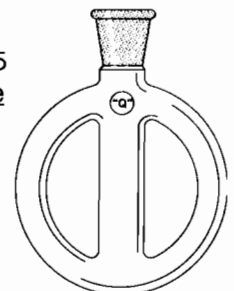

NOTE: ALL FLASKS, ROUND BOTTOM, FLAT BOTTOM, DISTILLING, BOILING, KJELDAHL, ERLLENMEYER, ETC. ARE AVAILABLE IN DIFFERENT JOINT COMBINATIONS OR NECK POSITIONS OTHER THEN THOSE LISTED IN THIS CATALOG. PLEASE CALL WITH YOUR SPECIAL REQUIREMENTS.

FLASKS

QF-4020 FLASK MORTON TYPE

3 straight necks with four indentations for improved stirring.

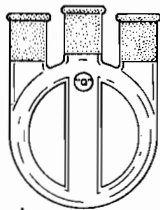

Capacity ML	Center Neck	Side Neck 24/40 Code	Side Neck 29/42 Code
500	24/40	-110	---
500	29/42	-111	-229
500	34/45	-112	-230
1000	24/40	-113	---
1000	29/42	-114	-231
1000	34/45	-115	-232
1000	45/50	-116	-233
2000	24/40	-117	---
2000	29/42	-118	-234
2000	34/45	-119	-235
2000	45/50	-120	-236
3000	24/40	-121	---
3000	29/42	-122	-237
3000	34/45	-123	-238
3000	45/40	-124	-239
5000	24/40	-125	---
5000	29/42	-126	-240
5000	34/45	-127	-241
5000	45/50	-128	-242

QF-4030 FLASK MORTON TYPE

4 straight necks with four indentations for improved stirring.

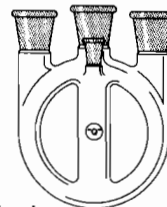

Capacity ML	Center Neck	Side Neck 24/40 Code	Side Neck 29/42 Code
500	24/40	-110	---
500	29/42	-111	-229
500	34/45	-112	-230
1000	24/40	-113	---
1000	29/42	-114	-231
1000	34/45	-115	-232
1000	45/50	-116	-233
2000	24/40	-117	---
2000	29/42	-118	-234
2000	34/45	-119	-235
2000	45/50	-120	-236
3000	24/40	-121	---
3000	29/42	-122	-237
3000	34/45	-123	-238
3000	45/40	-124	-239
5000	24/40	-125	---
5000	29/42	-126	-240
5000	34/45	-127	-241
5000	45/50	-128	-242

QF-4040 FLASK, METAL Single neck. Available in type 304 stainless steel or monel.

Capacity ML	Type 304 Stainless Steel				Monel			
	24/40 Code	29/42 Code	34/45 Code	45/50 Code	24/40 Code	29/42 Code	34/45 Code	45/50 Code
500	-110	-217	---	---	-530	-637	---	---
1000	-111	-218	---	---	-531	-638	---	---
2000	-112	-219	---	---	-532	-639	---	---
3000	-113	-220	---	---	-533	-640	---	---
5000	-114	-221	-324	-427	-534	-641	-744	-847
12000	-115	-222	-325	-428	-535	-642	-745	-848
22000	-116	-223	-326	-429	-536	-643	-746	-849

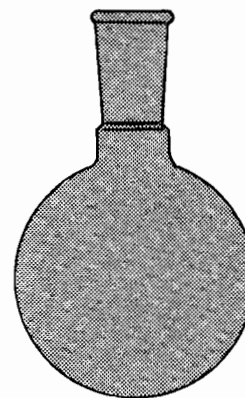

QF-4041 FLASK, METAL Single neck with side thermometer inlet. Available in type 304 stainless steel or monel.

Capacity ML	Type 304 Stainless Steel				Monel			
	24/40 Code	29/42 Code	34/45 Code	45/50 Code	24/40 Code	29/42 Code	34/45 Code	45/50 Code
500	-110	-217	---	---	-530	-637	---	---
1000	-111	-218	---	---	-531	-638	---	---
2000	-112	-219	---	---	-532	-639	---	---
3000	-113	-220	---	---	-533	-640	---	---
5000	-114	-221	-324	-427	-534	-641	-744	-847
12000	-115	-222	-325	-428	-535	-642	-745	-848
22000	-116	-223	-326	-429	-536	-643	-746	-849

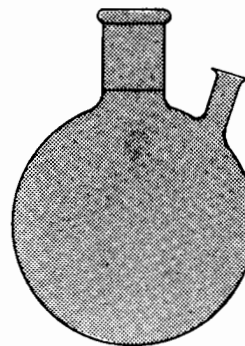

FLASKS

QF-4042 FLASK METAL

2 neck. Available in type 304 stainless steel or monel.

Side Necks

Capacity ML	Center Neck	Type 304 Stainless steel		Monel	
		24/40 Code	29/42 Code	24/40 Code	29/42 Code
500	24/40	-110	---	-340	---
500	29/42	-111	-228	-341	-458
1000	24/40	-112	---	-342	---
1000	29/42	-113	-229	-343	-459
2000	24/40	-114	---	-344	---
2000	29/42	-115	-230	-345	-460
3000	24/40	-116	---	-346	---
3000	29/42	-117	-231	-347	-461
5000	24/40	-118	---	-348	---
5000	29/42	-119	-232	-349	-462
5000	34/45	-120	-233	-350	-463
5000	45/50	-121	-234	-351	-464
12000	24/40	-122	---	-352	---
12000	29/42	-123	-235	-353	-465
12000	34/45	-124	-236	-354	-466
12000	45/50	-125	-237	-355	-467
22000	34/45	-126	-238	-356	-468
22000	45/50	-127	-239	-357	-469

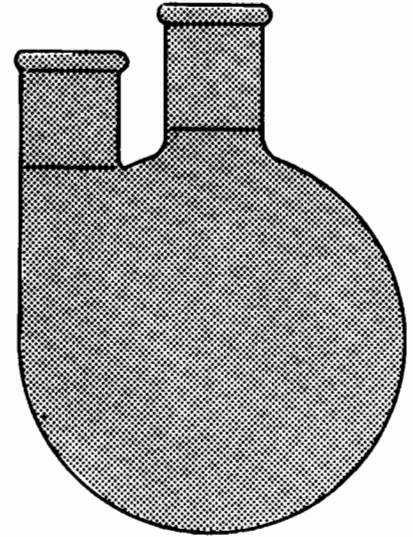

QF-4043 FLASK METAL

3 neck. Available in type 304 stainless steel or monel.

Side Necks

Capacity ML	Center Neck	Type 304 Stainless steel				Monel			
		24/40 Code	29/42 Code	34/45 Code	45/50 Code	24/40 Code	29/42 Code	34/45 Code	45/50 Code
500	24/40	-110	---	---	---	-549	---	---	---
500	29/42	-111	-228	---	---	-550	-667	---	---
1000	24/40	-112	---	---	---	-551	---	---	---
1000	29/42	-113	-229	---	---	-552	-668	---	---
2000	24/40	-114	---	---	---	-553	---	---	---
2000	29/42	-115	-230	---	---	-554	-669	---	---
3000	24/40	-116	---	---	---	-555	---	---	---
3000	29/42	-117	-231	---	---	-556	-670	---	---
5000	24/40	-118	---	---	---	-557	---	---	---
5000	29/42	-119	-232	---	---	-558	-671	---	---
5000	34/45	-120	-233	-340	---	-559	-672	-779	---
5000	45/50	-121	-234	-341	-446	-560	-673	-780	-885
12000	24/40	-122	---	---	---	-561	---	---	---
12000	29/42	-123	-235	---	---	-562	-674	---	---
12000	34/45	-124	-236	-342	---	-563	-675	-781	---
12000	45/50	-125	-237	-343	-447	-564	-676	-782	-886
22000	34/45	-126	-238	-344	---	-565	-677	-783	---
22000	45/50	-127	-239	-345	-448	-566	-678	-784	-887

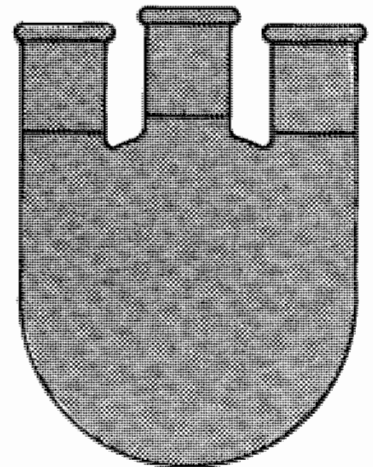

NOTE: ALL FLASKS, ROUND BOTTOM, FLAT BOTTOM, DISTILLING, BOILING, KJELDAHL, ERLIENMEYER, ETC. ARE AVAILABLE IN DIFFERENT JOINT COMBINATIONS OR NECK POSITIONS OTHER THAN THOSE LISTED IN THIS CATALOG. PLEASE CALL WITH YOUR SPECIAL REQUIREMENTS.

FLASKS

QF-4060 FLASK VOLUMETRIC

Class A. Calibrated to federal specifications NNN-F-289. Complete with stopper.

Capacity ML	Stopper Size	Code
5	9	-110
10	9	-111
25	9	-112
50	9	-113
100	13	-114
200	13	-115
250	16	-116
500	19	-117
1000	22	-118
2000	27	-119

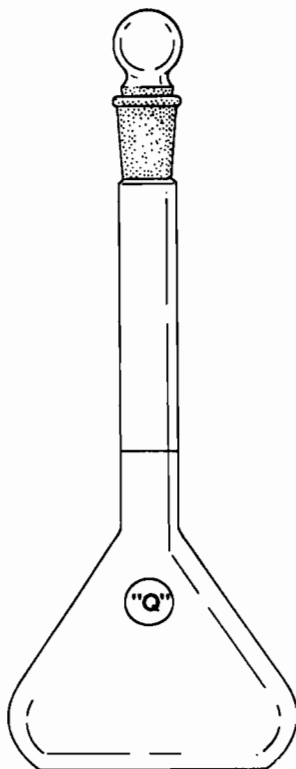

QF-4090 FLASK VOLUMETRIC

Used in dyehouse work. Bates-Sugar.

Capacity ML	Code
100	-110
250	-111
500	-112

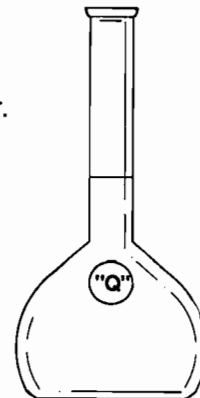

QF-4093 FLASK, LIQUID MEASURE

Calibrated to contain at 15.6° C. Graduated 20 divisions above zero mark and 10 divisions below.

Capacity, ML	Divisions, ML	Code
200	0.4	-110
250	0.5	-111
375	0.75	-112
500	1.0	-113
750	1.5	-114
1000	2.0	-115
1750	3.5	-116
2000	4.0	-117
4000	8.0	-118

QF-4070 FLASK VOLUMETRIC POLYPROPYLENE

Individually calibrated to contain and to deliver at 20° C. Marked with a permanent color graduation line and oval marking spot. Complete with polypropylene closure. Autoclavable.

Capacity ML	Code
50	-110
100	-111
200	-112
250	-113
500	-114
1000	-115

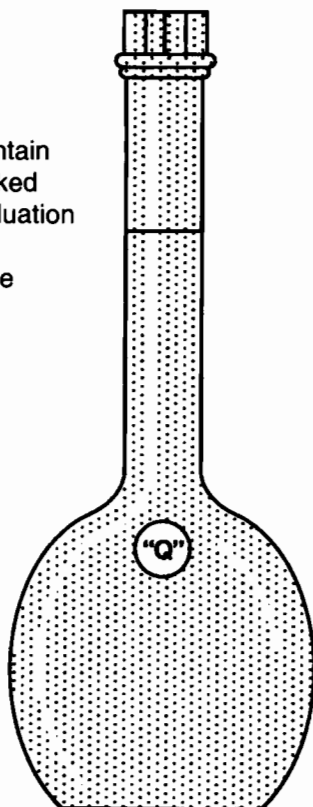

QF-4094 FLASK, LIQUID MEASURE

Calibrated to contain for 90 proof whiskey at temperatures from 5 to 40° C with 15.6° C as the standard temperature. Available in other proofs, capacities or standard temperatures as a special order.

Capacity, ML	Code
250	-110
500	-111
750	-112
1000	-113
2000	-114
4000	-115

QF-4094A FLASK

Similar to QF-4094 but graduated in U.S. customary capacities and the temperatures are from 40 to 100° F with 60° F as the standard temp.

Capacity	Code
1/2 pint	-110
1 pint	-111
4/5 quart	-112
1 quart	-113
1/2 gallon	-114
1 gallon	-115

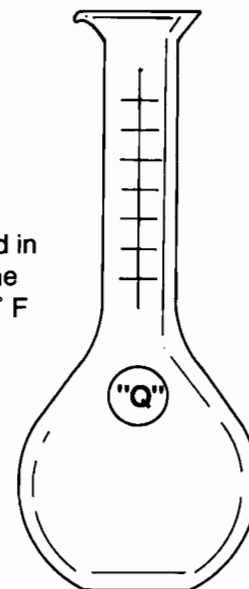

FLASKS

QF-4095 FLASK LIQUID MEASURE

U.S. customary capacities. Recommended by weights and measures officials for checking contents of packaged liquids per the N.B.S. handbook 105-2. Calibrated to deliver, (10 second drain) and standardized at 68° F.

Capacity	Code
2 Fl. Oz.	-110
1 Gill	-111
1/2 pint	-112
1 pint	-113
1 quart	-114
1/2 gallon	-115
1 gallon	-116

QF-4096 FLASK LIQUID MEASURE

Metric capacities. Recommended by weights and measures officials for checking contents of packaged liquids per the N.B.S. handbook 105-2. Calibrated to deliver, (10 second drain) and standardized at 20° C.

Capacity, ML	Code
50	-110
100	-111
250	-112
500	-113
1000	-114
2000	-115
4000	-116

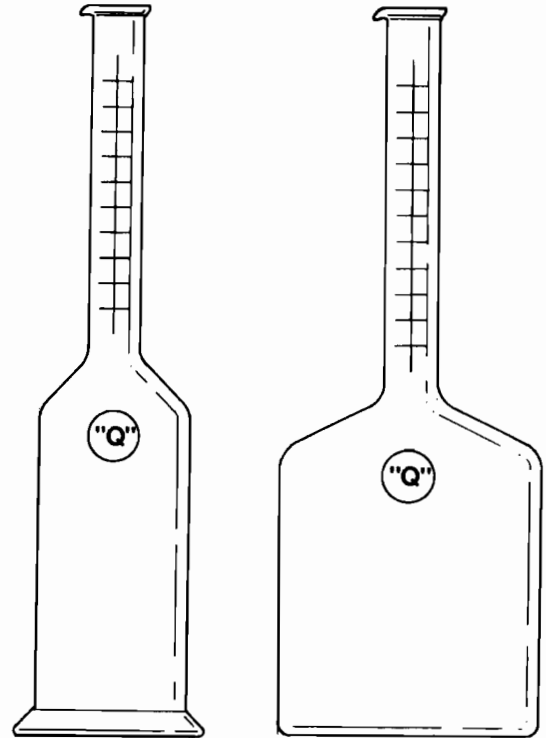

FUNNELS

QF-4097 BUCHNER FUNNEL FILTER

Funnels are available with fritted discs in three different porosities. Fritted disc is sealed in.

Capacity ML	Approximate Disc Diameter	Codes		
		Fine	Medium	Coarse
2	10	-110	-219	-328
15	20	-111	-220	-329
30	30	-112	-221	-330
60	40	-113	-222	-331
150	60	-114	-223	-332
350	80	-115	-224	-333
600	90	-116	-225	-334
2000	125	-117	-226	-335
3000	150	-118	-227	-336

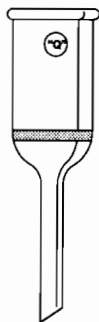

QF-4097P BUCHNER FUNNEL FILTER, POLYPROPYLENE

Durable 2 piece funnel consists of cup and funnel with perforated plate. Can be separated easily for cleaning. Autoclavable.

Capacity ML	Approximate Disc Diameter	Code
83	59	-110
186	76	-111
358	93	-112
919	130	-113
2906	172	-114

